

PRICE LIST
 **DUPUY**

WET & DRY

- PROVAC 150 D - 300 WD	10
- PROVAC 702 WD - 703C WD	11
- WD 1500 - WD 1500C	12
- WD 3000 - WD 4500	13

DUST & HEAVY DUST
SINGLE PHASE

- W 1	16
- W 2	18
- W 3 - W 3 HV	19
- W 2 Infini M	21

THREE PHASE

- W 2 Infini T	21
- W 3 Infini	22

THREE PHASE - MEDIUM POWER

- M50 - M50 HV - M70 - M90	24
----------------------------	----

THREE PHASE - HIGH POWER

- MHD 100 - MHD 130 - MHD 150 - MHD 200	26
- MHD 130 HV - MHD 180 HV - MHD 250 HV	27

MEDIUM AND HIGH POWER - PNEUMATIC FILTER CLEANING VERSION

- M SERIES - MHD SERIES	29
-------------------------	----

FIXED SUCTION UNIT

- SK 10 - SK 20 - SK 30 - SK 40	31
---------------------------------	----

COMPRESSED AIR VACUUM

- WD 3000 AIR	34
- W1 AIR	35
- W2 AIR	36
- W3 AIR	37

CENTRALIZED VACUUM SYSTEM

- SILOVAC	40
- SILOFILTER	44
- SILOBAG	46
- CVAC	48

OIL & CHIPS

- CHIPVAC 200 - 200 HV - 400M - 400M HV	54
- CHIPVAC 400 - 400HD	56
- OILVAC 60 - 100 - 100 PUMP	57
- OILVAC 130 - 130 PUMP	58
- OILVAC 200 - 200 T	59
- OILVAC 300	60
- OILVAC 450 HV - 600 HV	61
- OILVAC 500	63

OIL MIST	
- SKY	66
<hr/>	
DUST COLLECTORS	
- DEDUST PRO	70
- DEDUST 1 - 2 - 4 - 8	72
<hr/>	
WELDING FUME EXTRACTORS	
- FUMEBUSTER PRO	78
- FUMEBUSTER	79
- FUMEVAC	80
<hr/>	
ATEX	
- INDUSTRIAL VACUUM CLEANER	83
- COMPRESSED AIR VACUUM CLEANER	92
- CENTRALIZED VACUUM SYSTEM	96
- INERTING VACUUM SOLUTION	106
<hr/>	
OPTIONAL & ACCESSORIES	
- PRESEPARATORS WITH FILTER	108
- CYCLONIC PRESEPARATORS	109
- COVER AND DRUM ADAPTOR	110
- OPTIONAL	111
- ACCESSORY KIT	113
- CONNECTIONS	120
- SUCTION INLET	123
- FLEXIBLE HOSES	124
- HOSE CUFFS	128
- ACCESSORY	129
- FILTERS	134
- SPARE PARTS	138
- SENSORS	142
- DISCHARGE VALVE	143
- SAFETY	147

FILTRATION / FILTRAZIONE

L	Filter for fine dust - Class L >99% of the dust with a particle size smaller than 3µ <i>Filtro per polveri sottili - Classe L >99% della polvere con granulometria inferiore a 3µ</i>
M	Filter for fine dust - Class M >99,9% of the dust with a particle size smaller than 2µ <i>Filtro per polveri sottili - Classe M >99,9% della polvere con granulometria inferiore a 2µ</i>
ANT M	Antistatic filter Class M <i>Filtro Antistatico Classe M</i>
PTFE ANT	Polytetrafluoroethylene coated antistatic filter <i>Filtro Antistatico con rivestimento in Politetrafluoroetilene</i>
N	Nomex - Heat resistant filter (up to 200° Celsius) <i>Nomex - Filtro resistente alle alte temperature (fino a 200° Celsius)</i>
H14	Absolute HEPA filter - Class H14 >99,995% of the dust with a particle size of less than 1µ <i>Filtro HEPA assoluto - Classe H14 >99,995% della polvere con granulometria inferiore a 1µ</i>
TF OWR	Teflon filter Hydro-Oleophobic <i>Filtro Teflonato Idro-oleofobico</i>
PPL100	PPL Oil filtration kit down to 100µ (Suction) <i>Kit filtro PPL olio fino a 100µ (In aspirazione)</i>

CONSTRUCTION / COSTRUZIONE

X	Stainless Steel AISI 304 tank <i>Contenitore in acciaio Inox AISI 304</i>
XX	Stainless Steel AISI 304 tank and filter chamber <i>Contenitore e camera filtrante in acciaio Inox AISI 304</i>
EG	Earth grounding <i>Messa a terra</i>
PRF	Pressure relief valve <i>Valvola limitatrice di vuoto</i>
AB	Accessory basket <i>Portaccessori</i>
LD	Liquids discharge <i>Kit scarico liquidi</i>
LP	Longopac bagging system 20mt <i>Sistema di insaccamento longopac 20mt</i>
SR	Steel ring for suction into disposable bags <i>Anello in acciaio fermasacco</i>
PD	Pressure differential kit for use of disposable bag <i>Kit depressore per longopack</i>
RC	Electronic system for remote control from electrical tool <i>Sistema elettronico per controllo da remoto da elettroutensile</i>
CYC	Cyclone for filter protection <i>Ciclone per protezione filtro</i>
SG	Sieved grid <i>Cestello grigliato</i>
SG + DV	Sieved grid with discharge valve <i>Cestello grigliato con valvola di scarico</i>
ADD/SIL	Additional silencer <i>Silenziatore addizionale</i>
FORK/INT	Fork lift intakes <i>Inforcabile con carrello elevatore</i>
HARDOX	Abrasion proof plate in Hardox steel for filter chamber <i>Piastra rinforzo in Hardox resistente ad abrasione per bocchettone tangenziale della camera filtrante</i>
AUT	Automatic filter shaking cleaning for star filter <i>Sistema di pulizia filtro tramite cilindro pneumatico</i>

BUFFERSTOCK - FAST DELIVERY PRODUCTS / PRODOTTI IN CONSEGNA VELOCE

Need a super-fast delivery?

Take advantage of Du-Puy Bufferstock range of products!

A wide and full range of vacuum cleaners always available and ready for shipment to promptly meet your customer's needs.

Conditions:

- Bufferstock orders are accepted if single and separate from any other order. The "Bufferstock 5 days" lettering and the specific reference code must be clearly stated in the order;
- All Bufferstock orders cannot exceed the maximum quantity of 5 vacuums (max 2 with the same reference code);
- "5 days" refers to five working days from the date of the receipt of the written order.

Serve una consegna ultraveloce?

Approfitta della gamma Bufferstock di Du-Puy!

Una gamma di macchine ampia e completa è sempre a tua disposizione per rispondere prontamente alle richieste dei clienti.

Condizioni:

- Ordine unico e separato che riporti dicitura di richiesta/codice del "Bufferstock 5gg";
- Ogni ordine di Buffertock potrà includere al massimo 5 pezzi (massimo 2 dello stesso codice);
- I 5 giorni lavorativi si intendono lavorativi dalla data di ricevimento effettivo dell'ordine scritto.



5 DAYS DELIVERY

CODE / CODICE	DESCRIPTION / DESCRIZIONE	PRICE / PREZZO
PROVAC150-001	PROVAC 150 DRY C/KIT D32	€ 246,00
PROVAC300-001	PROVAC 300 WET&DRY C/KIT D32	€ 339,00
PROVAC702-001	PROVAC 702 WET&DRY C/KIT D40	€ 647,00
PROVAC703C-001	PROVAC 703 C WET&DRY C/KIT D40	€ 832,00
W1-001	W1 C/KIT D32	€ 1.135,00
W2-001	W2 C/KIT D40	€ 1.518,00
W3-001	W3 65LT C/KIT D50	€ 2.085,00
W3INFINI-001	W3 INFINI 65LT 4KW 400V C/KIT D50	€ 3.652,00
OILVAC60-001	OILVAC 60 KIT ACC.D38 PU	€ 1.337,00
OILVAC130PUMP-001	OILVAC 130 PUMP PPL300	€ 4.059,00
FUMEBUSTERPRO-001	FUMEBUSTER PRO HEPA AC 0,55KW 230V	€ 2.505,00
FUMEBUSTER-001	FUMEBUSTER HEPA 1,1KW 400V	€ 3.215,00
FUMEBUSTER-002	FUMEBUSTER AC CARBONI ATTIVI 1,5KW 400V	€ 3.950,00

WET & DRY RANGE

**PROFESSIONAL SINGLE PHASE VACUUM
CLEANERS FOR DUSTS AND LIQUIDS**

*ASPIRATORI MONOFASE PROFESSIONALI PER
POLVERI E LIQUIDI.*

PROFESSIONAL APPLICATIONS



INDUSTRIAL APPLICATIONS





Kit WD Ø32 included /incluso



Kit WD Ø40 included /incluso

Single-phase vacuum cleaner

Powerful and compact. With frontal suction inlet.
 Accessories included. Ideal for cleaning contractors.
 One powerful motor, different models for dry or Wet & Dry service.
 Available with direct bagging option.
 Extremely silent

Aspiratori professionali monofase

Compatti e leggeri. Con bocchettone frontale.
 Accessori inclusi, ideali per i professionisti del pulito.
 1 potente motore industriale by-pass per aspirazione polveri e liquidi.
 Possibilità di insaccamento diretto del materiale aspirato.
 Massima silenziosità.

TECHNICAL DATA / DATI TECNICI		PROVAC 150 D	PROVAC 300 WD
Voltage / Tensione	V - Hz	230 - 50 1~	230 - 50 1~
Power / Potenza	kW	0,9	1,1
Waterlift max. / Depressione max.	mm.H ₂ O	1.900	2.400
Air Flow max. / Portata d'aria max.	M ³ /h	180	180
Filter surface / Superficie filtrante	Cm ²	1.000	2.000
Filter type / Tipo di filtro		Sacco / Bag	
Media, class / Media, classe (IEC 60335-2-69)		Polyester - L	
Tank capacity / Capacità contenitore	Lt.	15	34
Noise level / Rumorosità (EN ISO 3744)	dB(A)	64	67
Dimensions / Dimensioni	cm.	38x34x44h	37x39x68h
Weight / Peso	kg.	8	12

Standard version price / Prezzo versioni standard	Prezzo / Price / €	
PROVAC 150 DRY	PROVAC150-001	€ 246,00
PROVAC 300 WET & DRY	PROVAC300-001	€ 339,00

PROVAC 702 WD - 703C WD

Single-phase vacuum cleaner

Powerful and compact. With 2 and 3 single phase motors.
 With frontal suction inlet.
 Accessories included. Ideal for cleaning contractors.
 Available with tilting container.
 Extremely silent

Aspiratori professionali monofase

Compatti e leggeri. Con 2 e 3 motori monofase.
 Con bocchettone frontale.
 Accessori inclusi, ideali per i professionisti del pulito.
 Possibilità di aspiratore con contenitore basculante.
 Massima silenziosità.



Kit WD Ø40 included /incluso

TECHNICAL DATA / DATI TECNICI		PROVAC 702 WD	PROVAC 703C WD
Voltage / Tensione	V - Hz	230 - 50 1~	230 - 50 1~
Power / Potenza	kW	2 x 1,1	3 x 1,1
Waterlift max. / Depressione max.	mm.H ₂ O	2.400	2.400
Air Flow max. / Portata d'aria max.	M ³ /h	360	540
Filter surface / Superficie filtrante	Cm ²	7.000	7.000
Filter type / Tipo di filtro		Sacco/Bag	
Media, class / Media, classe (IEC 60335-2-69)		Polyester - L	
Tank capacity / Capacità contenitore	Lt.	70	
Noise level / Rumorosità (EN ISO 3744)	dB(A)	70	74
Dimensions / Dimensioni	cm.	48x48x97h	53x55x98h
Weight / Peso	kg.	22	24

Standard version price / Prezzo versioni standard	Prezzo / Price / €	
PROVAC 702	PROVAC702-001	€ 647,00
PROVAC 703C	PROVAC703C-001	€ 832,00

Optionals / Opzioni	Price / Prezzo / €	
PROVAC 702 - Liquids discharge kit / Kit tubo scarico liquidi	PROVAC702-002	LD + € 80,00



Kit WD Ø40 TA.0614.00000 included /
incluso WD 1500, WD 1500C



Single-phase vacuum cleaner

Powerful and compact.

Accessories included. Ideal for cleaning contractors.

One powerful motor, different models for dry or Wet & Dry service.

Available with direct bagging option.

Extremely silent

Aspiratori professionali monofase

Compatti e potenti e leggeri.

Accessori inclusi, ideali per i professionisti del pulito.

1 potente motore industriale by-pass per aspirazione polveri e liquidi.

Possibilità di insaccamento diretto del materiale aspirato.

Massima silenziosità.

TECHNICAL DATA / DATI TECNICI		WD 1500	WD 1500C
Voltage / Tensione	V - Hz	230 - 50 1~	230 - 50 1~
Power / Potenza	kW	1,1	1,1
Waterlift max. / Depressione max.	mm.H ₂ O	2.400	2.400
Air Flow max. / Portata d'aria max.	M ³ /h	180	180
Filter surface / Superficie filtrante	Cm ²	2.000	2.000
Filter type / Tipo di filtro		Sacco/Bag	
Ø filter / Ø filtro	mm.	400	
Media, class / Media, classe (IEC 60335-2-69)		Polyester - L	
Tank capacity / Capacità contenitore	Lt.	65	
Dimensions / Dimensioni	cm.	53x53x89h	68x53x89h
Weight / Peso	kg.	15	21

Standard version price / Prezzo versioni standard	Prezzo / Price / €	
WD 1500	WD1500-001	€ 743,00
WD 1500C	WD1500C-001	€ 897,00

WD 3000 - WD 4500

 Tilting container
 Contenitore basculante

 Kit Wet&Dry Ø50 standard included / incluso
WD 3000 - WD 4500

Single-phase vacuum cleaner for food industry, cleaning contractors, mechanical industry

100 % Steel construction.

Suitable for Wet & Dry service (also at the same time).

Floating device and dry polyester filter included.

Tilting container to easy emptying of 60 lt.

Compact and portable, ideal for technical cleaning of work environments.

Aspiratore industriale monofase per meccanica, alimentare, imprese di pulizia

Costruzione 100% in acciaio.

Adatto per l'aspirazione di polveri, solidi e liquidi, anche in contemporanea.

Galleggiante in alluminio e filtro poliestere per polveri.

Contenitore basculante per facilitarne lo svuotamento da 60 lt.

Compatto e leggero, ideale per le pulizie tecniche degli ambienti di lavoro.

TECHNICAL DATA / DATI TECNICI

		WD 3000	WD 4500
Voltage / Tensione	V - Hz	230 - 50 1~	230 - 50 1~
Power / Potenza	kW	2 x 1,1	3 x 1,1
Waterlift max. / Depressione max.	mm.H ₂ O	2.400	2.400
Air Flow max. / Portata d'aria max.	M ³ /h	360	540
Filter surface / Superficie filtrante	Cm ²	5.000	7.000
Filter type / Tipo di filtro		Bag / Sacco	
Ø filter / Ø filtro	mm.	420	460
Media, class / Media, classe (IEC 60335-2-69)		Polyester - L	
Tank capacity / Capacità contenitore	Lt.	60	100
Ø Suction inlet / Ø Bocchettone	mm.	50	80
Noise level / Rumorosità (EN ISO 3744)	dB(A)	78	78
Dimensions / Dimensioni	cm.	62x60x100h	76x76x108h
Weight / Peso	kg.	32	37

Standard version price / Prezzo versioni standard

	Price / Prezzo / €	
WD 3000	WD3000-001	€ 1.304,00
WD 4500	WD4500-001	€ 1.821,00

Recommended accessory / Accessori consigliati

	Price / Prezzo / €	
Ø50 Rubber cone nozzle / Tronco conico in gomma		TA.0014.0000 € 49,00
Ø50 Double bend / Doppia curva		SL.0170.7016 € 81,00
Ø50 Wheeled floor brush / Spazzola pavimento con ruote		TA.0141.0000 € 105,00
Ø50 Wheeled squeegee / Spazzola ventosa con ruote		TA.0132.0000 € 105,00



DUST & HEAVY DUST

SINGLE PHASE & THREE PHASE INDUSTRIAL VACUUM CLEANERS FOR DUSTS, SOLIDS AND LIQUIDS

ASPIRATORI INDUSTRIALI MONOFASE E TRIFASE PER POLVERI, SOLIDI E LIQUIDI

SINGLE-PHASE



THREE-PHASE

LIGHT

MEDIUM

HEAVY



 Kit Wet & Dry Ø32 **TA.1156.0000** included / incluso

The most efficient, compact and lightest vacuum cleaner on the market

100% Steel construction.
 Less than one metre height and less than 20 kg weight.
 Suitable for wet, dry and dust applications at the same time.
 Integrated filter cleaning shaker 2.0.
 Quick release detachable container with possibility of use disposable bags.





Il più efficiente, compatto e leggero aspiratore industriale sul mercato

Costruzione 100% acciaio.
 Meno di 1 metro di altezza e meno di 20Kg di peso.
 Possibilità di aspirare contemporaneamente polveri, liquidi e solidi.
 Sistema migliorato di pulizia manuale del filtro integrato.
 Contenitore a sgancio rapido, con possibilità di insaccamento.

TECHNICAL DATA / DATI TECNICI		W 1
Voltage / Tensione	V - Hz	230 - 50 1~
Power / Potenza	kW	1,1
Water Lift max. / Depressione max.	mm.H ₂ O	2.400
Air Flow max. / Portata d'aria max.	M ³ /h	180
Filter surface / Superficie filtrante	Cm ²	8.000
Filter type / Tipo di filtro		Star / Tasche
Ø filter / Ø filtro	mm.	280
Media, class / Media, classe (IEC 60335-2-69)		Polyester - L
Tank capacity / Capacità contenitore	Lt.	15
Noise level / Rumorosità (EN ISO 3744)	dB(A)	76
Dimensions / Dimensioni	cm.	43x40x96h
Weight / Peso	kg.	20

Standard version price / Prezzo versioni standard	Price / Prezzo / €	
W 1	W1-001	€ 1.135,00
W 1 Wall Mounted - Fissaggio a parete	 W1WM-001	€ 1.070,00

Optionals / Opzioni	Price / Prezzo / €	
Steel ring for suction into disposable bag / Anello in acciaio per aspirazione in sacchi a perdere	SR	+ € 73,50
Antistatic Class M filter / Filtro Classe M Antistatico	M ANT	+ € 55,00
PTFE Coated Antistatic Class M filter / Filtro Classe M PTFE Antistatico	PTFE ANT	+ € 194,00
Class M Teflon filter Hydro-Oleophobic / Filtro Classe M Teflonato Idro-oleofobico	TF OWR	+ € 110,00
Nomex - heat resistant filter up to 200°C / Filtro resistente al calore fino a 200°C	N	+ € 129,00
H14 Absolute filter kit / Filtro assoluto Hepa H14 - 12.000cm ² with 99,995% efficiency at 0,18µ	H14	+ € 259,00
Stainless steel collection tank AISI 304 / Contenitore in acciaio inox AISI 304	X	+ € 190,00
Stainless steel AISI 304 tank and filter chamber / Contenitore e camera in acciaio inox AISI 304	XX	+ € 422,00
Earth grounding / Messa a terra	EG	+ € 100,00

Packaging / Imballaggio	Size / Dimensioni
Single package w/o pallet / Imballo singolo senza pedana	 <p>26 Kg 45 x 48 x 105h</p>
4 pieces per package on pallet / 4 prodotti per imballo su pedana	 <p>115Kg 120 x 100 x 115h</p>
6 pieces per package on pallet / 6 prodotti per imballo su pedana	 <p>167Kg 120 x 100 x 165h</p>
8 pieces per package on pallet / 8 prodotti per imballo su pedana	 <p>209Kg 120 x 100 x 220h</p>

Recommended purchase quantities to optimise delivery costs / Quantitativi di acquisto consigliato per ottimizzazione delle spese di trasporto

 Kit Wet & Dry Ø40 TA.1292.0000
 included / incluso

Compact and portable industrial vacuum cleaner

100% Steel construction.

Suitable for wet, dry and dust applications at the same time.

High capacity detachable container with possibility of use disposable bags.

Filter clogging detector and integrated filter cleaning system.

Aspiratore industriale compatto ad alta mobilità

Costruzione 100% acciaio.

Possibilità di aspirare contemporaneamente polveri, liquidi e solidi.

Contenitore a sgancio rapido, con possibilità di insaccamento.

Indicatore di intasamento del filtro e sistema di pulizia manuale integrato.

TECHNICAL DATA / DATI TECNICI		W 2
Voltage / Tensione	V - Hz	230 - 50 1~
Power / Potenza	kW	2 x 1,1
Water Lift max. / Depressione max.	mm.H ₂ O	2.400
Air Flow max. / Portata d'aria max.	M ³ /h	360
Filter surface / Superficie filtrante	Cm ²	20.000
Filter type / Tipo di filtro		Star / Tasche
Ø filter / Ø filtro	mm.	420
Media, class / Media, classe (IEC 60335-2-69)		Polyester - L
Tank capacity / Capacità contenitore	Lt.	40
Ø Suction inlet / Ø Bocchettone	mm.	50
Noise level / Rumorosità (EN ISO 3744)	dB(A)	78
Dimensions / Dimensioni	cm.	63x57x116h
Weight / Peso	kg.	44

Standard version price / Prezzo versioni standard	Price / Prezzo / €	
W 2	W2-001	€ 1.518,00

Optionals / Opzioni	Price / Prezzo / €	
Accessory basket / Cestino portaccessori	AB	+ € 83,00
Steel ring for suction into disposable bags / Anello in acciaio fermasacco	SR	+ € 81,00
Pressure differential kit for use of disposable bag / Kit depressore per uso con sacchi a perdere	PD	+ € 174,00
Antistatic Class M filter / Filtro Classe M Antistatico	M ANT	+ € 112,00
PTFE Coated Antistatic Class M filter / Filtro Classe M PTFE Antistatico	PTFE ANT	+ € 208,00
Class M Teflon filter Hydro-Oleophobic / Filtro Classe M Teflonato Idro-oleofobico	TF OWR	+ € 184,00
Nomex - heat resistant filter up to 200°C / Filtro resistente al calore fino a 200°C	N	+ € 108,00
H14 Absolute filter kit / Filtro assoluto Hepa H14 - 20.500cm ² with 99,995% efficiency at 0,18µ	H14	+ € 248,00
Stainless steel collection tank AISI 304 / Contenitore in acciaio inox AISI 304	X	+ € 254,00
Stainless steel AISI 304 tank and filter chamber / Contenitore e camera in acciaio inox AISI 304	XX	+ € 654,00
Electronic system for remote control from electrical tool / Sistema elettronico per controllo da remoto da elettroutensile	RC	+ € 254,00
Earth grounding / Messa a terra	EG	+ € 100,00

5%

 ADDITIONAL DISCOUNT FOR MINIMUM ORDER OF 5 UNITS OF W2, W3, W3 INFINI
 SCONTO QUANTITA' PER L'ACQUISTO DI ALMENO 5 ASPIRATORI TRA W2, W3, W3 INFINI

 Kit Accessory Ø50 TA.0645.0000
 included/ incluso

Compact and portable industrial vacuum cleaner

100% Steel construction.

Suitable for wet, dry and dust applications at the same time.

High capacity detachable container with possibility of use disposable bags.

Large filter surface with integrated filter cleaning system.

Aspiratore industriale compatto ad alta mobilità

Costruzione 100% acciaio.

Possibilità di aspirare contemporaneamente polveri, liquidi e solidi.

Contenitore a sgancio rapido, con possibilità di insaccamento.

Filtro di ampia superficie per polveri fini con sistema di pulizia manuale integrato.

TECHNICAL DATA / DATI TECNICI		W 3	W 3 HV
Voltage / Tensione	V - Hz	230 - 50 1~	230 - 50 1~
Power / Potenza	kW	3 x 1,1	2 x 1,6
Water Lift max. / Depressione max.	mm.H ₂ O	2.400	3.600
Air Flow max. / Portata d'aria max.	M ³ /h	540	340
Filter surface / Superficie filtrante	Cm ²	20.000	
Filter type / Tipo di filtro		Star / Tasche	
Ø filter / Ø filtro	mm.	420	
Media, class / Media, classe (IEC 60335-2-69) ²		Polyester - L	
Tank capacity / Capacità contenitore	Lt.	65 / 100	
Ø Suction inlet / Ø Bocchettone	mm.	80	
Noise level / Rumorosità (EN ISO 3744)	dB(A)	78	77
Dimensions / Dimensioni	cm.	70x62x135h	70x62x136h
Weight / Peso	kg.	67*	68*

*65lt standard version / Versione 65lt

Standard version price / Prezzo versioni standard	Price / Prezzo / €	
W 3	W3-001	€ 2.085,00
W 3 100lt	W3-005	€ 2.200,00
W 3 HV	W3HV-001	€ 2.558,00
W 3 HV 100lt	W3HV-002	€ 2.673,00

Recommended accessory / Accessori consigliati	Price / Prezzo / €		
Ø50 Rubber cone nozzle / Tronco conico in gomma		TA.0014.0000	€ 49,00
Ø50 Double bend / Doppia curva		SL.0170.7016	€ 81,00
Ø50 Wheeled floor brush / Spazzola pavimento con ruote		TA.0141.0000	€ 105,00
Ø50 Wheeled squeegee / Spazzola ventosa con ruote		TA.0132.0000	€ 105,00

5%

 ADDITIONAL DISCOUNT FOR MINIMUM ORDER OF 5 UNITS OF W2, W3, W3 INFINI
 SCONTO QUANTITA' PER L'ACQUISTO DI ALMENO 5 ASPIRATORI TRA W2, W3, W3 INFINI

Longopack 20mt bag container / <i>Contenitore insaccamento longopack 20mt</i>		LP	+ € 716,00
Steel ring for suction into disposable bags / <i>Anello in acciaio fermasacco</i>		SR	+ € 81,00
Pressure differential kit for use of disposable bag / <i>Kit depressore per uso con sacchi a perdere</i>		PD	+ € 174,00
Antistatic Class M filter / <i>Filtro Classe M Antistatico</i>		M ANT	+ € 112,00
PTFE Coated Antistatic Class M filter / <i>Filtro Classe M PTFE Antistatico</i>		PTFE ANT	+ € 208,00
Class M Teflon filter Hydro-Oleophobic / <i>Filtro Classe M Teflonato Idro-oleofobico</i>		TF OWR	+ € 184,00
Nomex -heat resistant filter up to 200°C / <i>Filtro resistente al calore fino a 200°C</i>		N	+ € 108,00
H14 Absolute filter kit with heightening ring / <i>Filtro assoluto Hepa H14 - 26.500cm² con fascia di rialzo with 99,995% efficiency at 0,18µ</i>		H14	+ € 480,00
Cyclon for filter protection / <i>Ciclone per protezione filtro</i>		CYC	+ € 152,00
Stainless steel 65lt. collection tank AISI 304 / <i>Contenitore 65lt. in acciaio inox AISI 304</i>		X	+ € 378,00
Stainless steel 100lt. collection tank AISI 304 / <i>Contenitore 100lt. in acciaio inox AISI 304</i>		X	+ € 420,00
Stainless steel 65lt. tank and filter chamber AISI 304 / <i>Contenitore 65lt. e camera in acciaio inox AISI 304</i>		XX	+ € 802,00
Stainless steel 100lt. tank and filter chamber AISI 304 / <i>Contenitore 100lt. e camera in acciaio inox AISI 304</i>		XX	+ € 844,00
Earth grounding / <i>Messa a terra</i>		EG	+ € 100,00



Kit Wet & Dry Ø40 **TA.1292.0000**
included / incluso

Three-phase industrial vacuum cleaner equipped with side channel blower for continuous work, maintenance free.

Suitable for wet, dry and dust applications at the same time.
Detachable container with possibility to use disposable bags.
Large filter surface with integrated filter cleaning system.

Aspiratore industriale compatto dotato di turbina a canale laterale per il servizio continuativo.

Prestazioni costanti senza necessità di manutenzioni.
Aspirazione simultanea di polveri, liquidi, solidi.
Contenitore a sgancio con possibilità di insaccamento.
Filtro di ampia superficie con sistema di pulizia manuale integrato.

TECHNICAL DATA / DATI TECNICI		W 2 Infini M	W 2 Infini T
Voltage / Tensione	V - Hz	230 - 50 1~	400 - 50 3~
Power / Potenza	kW	1,8	1,8
Water Lift max. / Depressione max.	mm.H ₂ O	2.300	2.300
Air Flow max. / Portata d'aria max.	M ³ /h	250	250
Filter surface / Superficie filtrante	Cm ²	20.000	
Filter type / Tipo di filtro		Star / Tasche	
Ø filter / Ø filtro	mm.	420	
Media, class / Media, classe (IEC 60335-2-69) ²		Polyester - L	
Tank capacity / Capacità contenitore	Lt.	40	
Ø Suction inlet / Ø Bocchettone	mm.	50	
Noise level / Rumorosità (EN ISO 3744)	dB(A)	74	
Dimensions / Dimensioni	cm.	63x58x130h	
Weight / Peso	kg.	58	59

Standard version price / Prezzo versioni standard	Price / Prezzo / €	
W 2 Infini M	W2INFINI-001	€ 2.683,00
W 2 Infini T	W2INFINI-002	€ 2.607,00

Optionals / Opzioni	Price / Prezzo / €	
Accessory basket / Cestino portaccessori	AB	+ € 83,00
Pressure relief valve / Valvola limitatrice di vuoto	PRF	+ € 114,00
Antistatic Class M filter / Filtro Classe M Antistatico	M ANT	+ € 112,00
PTFE Coated Antistatic Class M filter / Filtro Classe M PTFE Antistatico	PTFE ANT	+ € 208,00
Class M Teflon filter Hydro-Oleophobic / Filtro Classe M Teflonato Idro-oleofobico	TF OWR	+ € 184,00
Nomex -heat resistant filter up to 200°C / Filtro resistente al calore fino a 200°C	N	+ € 108,00
H14 Absolute filter kit / Filtro assoluto Hepa H14 - 26.500cm ² with 99,995% efficiency at 0,18µ	H14	+ € 367,00
Stainless steel collection tank AISI 304 / Contenitore in acciaio inox AISI 304	X	+ € 254,00
Stainless steel tank and filter chamber AISI 304 / Contenitore e camera in acciaio inox AISI 304	XX	+ € 654,00
Earth grounding / Messa a terra	EG	+ € 100,00
Remote Control / Avviamento locale remoto	RC	+ € 1.040,00

 Kit Accessory Ø50 TA.0645.0000
 incluso / included

Powerful Three-phase industrial vacuum cleaner equipped with side channel blower for continuous work, maintenance free.
 Suitable for wet, dry and dust applications at the same time.
 Detachable container with possibility to use disposable bags.
 Large filter surface with integrated filter cleaning system.

Aspiratore industriale trifase dotato di potente turbina a canale laterale per il servizio continuativo.

*Prestazioni costanti senza necessità di manutenzioni.
 Aspirazione simultanea di polveri, liquidi, solidi.
 Contenitore a sgancio con possibilità di insaccamento.
 Filtro di ampia superficie con sistema di pulizia manuale integrato.*

TECHNICAL DATA / DATI TECNICI		W 3 Infini 2,2kW	W 3 Infini 4kW
Voltage / Tensione	V - Hz	400 - 50 3~	400 - 50 3~
Power / Potenza	kW	2,2	4
Water Lift max. / Depressione max.	mm.H ₂ O	3.000	3.200
Air Flow max. / Portata d'aria max.	M ³ /h	320	420
Filter surface / Superficie filtrante	Cm ²	20.000	
Filter type / Tipo di filtro		Star / Tasche	
Ø filter / Ø filtro	mm.	420	
Media, class / Media, classe (IEC 60335-2-69) ²		Polyester - L	
Tank capacity / Capacità contenitore	Lt.	65	
Ø Suction inlet / Ø Bocchettone	mm.	80	
Noise level / Rumorosità (EN ISO 3744)	dB(A)	74	74
Dimensions / Dimensioni	cm.	108x62x137h	
Weight / Peso	kg.	105	120

Standard version price / Prezzo versioni standard	Price / Prezzo / €	
W 3 Infini 2,2kW	W3INFINI-003	€ 3.082,00
W 3 Infini 4kW	W3INFINI-001	€ 3.652,00
W 3 Infini 2,2kW Lt. 100 - NEW	W3INFINI-020	€ 3.198,00
W 3 Infini 4kW Lt. 100 - NEW	W3INFINI-021	€ 3.768,00

Recommended accessory / Accessori consigliati	Price / Prezzo / €		
Rubber cone nozzle / Tronco conico in gomma		TA.0014.0000	€ 49,00
Double bend / Doppia curva		SL.0170.7016	€ 81,00
Wheeled floor brush / Spazzola pavimento con ruote		TA.0141.0000	€ 105,00
Wheeled squeegee / Spazzola ventosa con ruote		TA.0132.0000	€ 105,00

5%
**ADDITIONAL DISCOUNT FOR MINIMUM ORDER OF 5 UNITS OF W2, W3, W3 INFINI
 SCONTO QUANTITA' PER L'ACQUISTO DI ALMENO 5 ASPIRATORI TRA W2, W3, W3 INFINI**

Optionals / Opzioni	Price / Prezzo / €	
Pressure relief valve / Valvola limitatrice di vuoto	PRF	+ € 177,00
Antistatic Class M filter / Filtro Classe M Antistatico	M ANT	+ € 112,00
PTFE Coated Antistatic Class M filter / Filtro Classe M PTFE Antistatico	PTFE ANT	+ € 208,00
Class M Teflon filter Hydro-Oleophobic / Filtro Classe M Teflonato Idro-oleofobico	TF OWR	+ € 184,00
Nomex -heat resistant filter up to 200°C / Filtro resistente al calore fino a 200°C	N	+ € 108,00
H14 Absolute filter kit / Filtro assoluto Hepa H14 - 26.500cm ² with 99,995% efficiency at 0,18µ	H14	+ € 380,00
Stainless steel 65lt. collection tank AISI 304 / Contenitore 65lt. in acciaio inox AISI 304	X	+ € 378,00
Stainless steel 100lt. collection tank AISI 304 / Contenitore 100lt. in acciaio inox AISI 304	X	+ € 420,00
Stainless steel 65lt. tank and filter chamber AISI 304 / Contenitore 65lt. e camera in acciaio inox AISI 304	XX	+ € 802,00
Stainless steel 100lt. tank and filter chamber AISI 304 / Contenitore 100lt. e camera in acciaio inox AISI 304	XX	+ € 844,00
Earth grounding / Messa a terra	EG	+ € 100,00
Remote Control / Avviamento locale remoto	RC	+ € 1.040,00

Three-phase industrial vacuum cleaner

High filtration efficiency , filter efficiency detector, integrated filter cleaning system.

Maintenance free motor suitable for continuous duty 24/7 work.

Detachable container with possibility to use disposable bags.

Possibility to vacuum dust, solid material, liquids at the same time.

Extremely silent.

Aspiratore industriale trifase

Alto livello di filtrazione, indicatore efficienza filtro, pulizia del filtro integrata.

Motore idoneo a servizio continuativo 24/7, senza necessità di manutenzione.

Contenitore a sgancio di grande capacità con possibilità di insaccamento.

Aspirazione simultanea di solidi, polveri e liquidi.

Massima silenziosità.

TECHNICAL DATA / DATI TECNICI		M50	M50 HV	M70	M90
Voltage / Tensione	V - Hz	400 - 50 3~	400 - 50 3~	400 - 50 3~	400 - 50 3~
Power / Potenza	kW	4	4,3	5,5	7,5*
Water Lift max. / Depressione max.	mm.H ₂ O	3.200	5.100	3.600	4.000
Continuous Waterlift / Depressione in continuo	mm.H ₂ O	2.700	3.600	3.000	2.700**
Air Flow max. / Portata d'aria max.	M ³ /h	420	320	530	700
Filter surface / Superficie filtrante	Cm ²	20.000		35.000	
Filter type / Tipo di filtro		Star / Tasche			
Ø filter / Ø filtro	mm.	420			
Media, class / Media, classe (IEC 60335-2-69) ²		Polyester - L			
Tank capacity / Capacità contenitore	Lt.	100			
Ø Suction inlet / Ø Bocchettone	mm.	80			
Noise level / Rumorosità (EN ISO 3744)	dB(A)	74	75	74	77
Dimensions / Dimensioni	cm.	119x65x160h		119x65x180h	
Weight / Peso	kg.	137	145	149	182

* Star-delta starting panel board included / Quadro elettrico avviamento stella-triangolo incluso.

** Pressure relief valve included as standard / Valvola limitatrice di vuoto inclusa di serie.

Standard version price / Prezzo versioni standard	Price / Prezzo / €	
M50	M50-001	€ 4.389,00
M50 HV	M50HV-001	€ 4.961,00
M70	M70-001	€ 5.022,00
M90	M90-001	€ 8.311,00

Optionals / Opzioni		Price / Prezzo / €	
Longopac 20mt bag container / Contenitore insaccamento longopac 20mt		LP	+ € 716,00
Configuration for discharging on grid or container, hopper capacity 90lt, discharge height from the ground 100mm <i>Predisposizione per scarico su grigliato o contenitore, capacità tramoggia 90lt, altezza scarico dal suolo 100mm</i>		GD	Upon Request
Steel ring for suction into disposable bags / Anello in acciaio fermasacco		SR	+ € 81,00
Pressure differential kit for use of disposable bag / Kit depressore per sacco a perdere		PD	+ € 174,00
Pressure relief valve / Valvola limitatrice di vuoto		PRF	+ € 177,00
(M50-M50HV-M70) Automatic filter shaker with pneumatic Cylinder with Timer and Push Button <i>Scuotifiltro automatico temporizzato con cilindro pneumatico ad aria compressa</i>		AUT	+ € 2.067,00
(M90) Automatic filter shaker with pneumatic Cylinder with Timer and Push Button <i>Scuotifiltro automatico temporizzato con cilindro pneumatico ad aria compressa</i>		AUT	+ € 1.080,00
Air compressor installed on board / Compressore installato a bordo macchina		COMP	+ € 1.144,00
(M50) Antistatic Class M filter / Filtro Classe M Antistatico		ANT M	+ € 112,00
(M50) PTFE Antistatic coated Class M filter / Filtro Classe M PTFE Antistatico		PTFE ANT	+ € 208,00
(M50) Class M Teflon filter Hydro-Oleophobic / Filtro Classe M Teflonato Idro-oleofobico		TF OWR	+ € 184,00
(M50) Nomex - heat resistant filter up to 200°C / Filtro resistente al calore fino a 200°C		N	+ € 108,00
(M50) 26500 cm ² - H14 Absolute filter kit / Filtro assoluto Hepa H14		H14	+ € 380,00
(M70-90) Antistatic Class M filter / Filtro Classe M Antistatico		ANT M	+ € 197,00
(M70-90) PTFE Antistatic coated Class M filter / Filtro Classe M PTFE Antistatico		PTFE ANT	+ € 380,00
(M70-90) Class M Teflon filter Hydro-Oleophobic / Filtro Classe M Teflonato Idro-oleofobico		TF OWR	+ € 300,00
(M70-90) Nomex - heat resistant filter up to 200°C / Filtro resistente al calore fino a 200°C		N	+ € 169,00
(M70-90) 52000 cm ² - H14 Absolute filter kit / Filtro assoluto Hepa H14		H14	+ € 566,00
Stainless steel collection tank AISI 304 / Contenitore in acciaio inox AISI 304		X	+ € 419,00
(M50) Stainless steel AISI 304 tank and filter chamber / Contenitore e camera in acciaio inox AISI 304		XX	+ € 843,00
(M70-90) Stainless steel AISI 304 tank and filter chamber / Contenitore e camera in acciaio inox AISI 304		XX	+ € 1.074,00
Earth grounding / Messa a terra		EG	+ € 147,00
Cyclon for filter protection / Ciclone per protezione filtro		CYC	+ € 152,00
Additional silencer / Silenziatore supplementare		ADD/SIL	+ € 150,00
Forklift intakes / Predisposizione inforcamento muletto		FORK/INT	+ € 214,00
(M50-M50HV-M70) Remote Control / Avviamento locale remoto		RC	+ € 1.040,00
(M90) Remote Control / Avviamento locale remoto		RC	+ € 237,00

Recommended accessory / Accessori consigliati		Price / Prezzo / €	
(M Series) - Kit accessori WD Ø50 consigliato / Recommended Ø50 WD accessory kit		TA.0617.0000	€ 309,00
(M Series) - Kit accessori Dry Ø50 consigliato / Recommended Ø50 Dry accessory kit		TA.0618.0000	€ 309,00

TA.0617.0000



TA.0618.0000



Heavy duty three-phase industrial vacuum cleaner suitable for mobile services or fixed central vacuum systems.

High filtration efficiency , filter efficiency detector, integrated filter cleaning system.

Maintenance free motor suitable for continuous duty 24/7 work.

Large capacity detachable container.

Forklift intakes for easy transport.

Possibility to vacuum dust, solid material, liquids at the same time.

Extremely silent.

Aspiratore industriale trifase per applicazioni pesanti sia in servizio mobile che su impianti centralizzati.

Alto livello di filtrazione, indicatore efficienza filtro, pulizia del filtro integrata.

Motore idoneo a servizio continuativo 24/7, senza necessità di manutenzione.

Contenitore a sgancio a grande capacità. Inforcabile con muletto.

Aspirazione simultanea di solidi, polveri e liquidi.

Massima silenziosità.

TECHNICAL DATA / DATI TECNICI		MHD100	MHD130	MHD150	MHD200
Voltage / Tensione	V - Hz	400 - 50 3~	400 - 50 3~	400 - 50 3~	400 - 50 3~
Power / Potenza	kW	7,5	11	12,5	18,5
Water Lift max. / Depressione max.	mm.H ₂ O	4.500	4.000	4.400	4.400
Continuous Waterlift / Depressione in continuo	mm.H ₂ O	3.200	2.600	2.900	3.200
Air Flow max. / Portata d'aria max.	M ³ /h	750	1.050	1.100	1.350
Filter surface / Superficie filtrante	Cm ²	70.000			
Filter type / Tipo di filtro		Star / Tasche			
Ø filter / Ø filtro	mm.	560			
Media, class / Media, classe (IEC 60335-2-69) ²		Polyester - L			
Tank capacity / Capacità contenitore	Lt.	160			
Ø Suction inlet / Ø Bocchettone	mm.	120			
Noise level / Rumorosità (EN ISO 3744)	dB(A)	74	75	78	81
Dimensions / Dimensioni	cm.	163x76x200h			
Weight / Peso	kg.	332	390	430	430

Standard version price / Prezzo versioni standard		Price / Prezzo / €	
MHD 100		MHD100-001	€ 12.458,00
MHD 130		MHD130-001	€ 13.684,00
MHD 150		MHD150-001	€ 15.037,00
MHD 200		MHD200-001	€ 17.633,00



Heavy duty High Vacuum three-phase industrial vacuum cleaner suitable for mobile services or fixed central vacuum systems. High filtration efficiency , filter efficiency detector, integrated filter cleaning system.

Maintenance free motor suitable for continuous duty 24/7 work. Large capacity detachable container.

Forklift intakes for easy transport.

Possibility to vacuum dust, solid material, liquids at the same time.

Extremely silent.

Aspiratore industriale trifase per applicazioni pesanti sia in servizio mobile che su impianti centralizzati.

Alto livello di filtrazione, indicatore efficienza filtro, pulizia del filtro integrata.

Motore idoneo a servizio continuativo 24/7, senza necessità di manutenzione.



Contenitore a sgancio a grande capacità. Inforcabile con muletto.

Aspirazione simultanea di solidi, polveri e liquidi.

Massima silenziosità.

TECHNICAL DATA / DATI TECNICI		MHD 130HV	MHD 180HV	MHD 250HV
Voltage / Tensione	V - Hz	400 - 50 3~	400 - 50 3~	400 - 50 3~
Power / Potenza	kW	11	17,3	20
Water Lift max. / Depressione max.	mm.H ₂ O	5.100	6.000	5.000
Continuous Waterlift / Depressione in continuo	mm.H ₂ O	4.300	5.400	4.400
Air Flow max. / Portata d'aria max.	M ³ /h	520	720	1.100
Filter surface / Superficie filtrante	Cm ²	70.000		
Filter type / Tipo di filtro		Star / Tasche		
Ø filter / Ø filtro	mm.	560		
Media, class / Media, classe (IEC 60335-2-69) ²		Polyester - L		
Tank capacity / Capacità contenitore	Lt.	160		
Ø Suction inlet / Ø Bocchettone	mm.	120		
Noise level / Rumorosità (EN ISO 3744)	dB(A)	78	78	78
Dimensions / Dimensioni	cm.	163x76x200h		
Weight / Peso	kg.	390	421	450

Standard version price / Prezzo versioni standard	Price / Prezzo / €	
MHD 130HV	MHD130HV-001	€ 13.801,00
MHD 180HV	MHD180HV-001	€ 18.928,00
MHD 250HV - NEW	MHD250HV-001	€ 21.131,00

Opzioni / Options		Price / Prezzo / €	
Configuration for discharging on grid or container, hopper capacity 90lt, discharge height from the ground 100mm <i>Predisposizione per scarico su grigliato o contenitore, capacità tramoggia 90lt, altezza scarico dal suolo 100mm</i>		GD	Upon Request
Automatic filter shaker with pneumatic Cylinder with Timer and Push Button <i>Scuotifiltro automatico temporizzato con cilindro pneumatico ad aria compressa</i>		AUT	+ € 2.044,00
Air compressor installed on board / <i>Compressore installato a bordo macchina</i>		COMP	+ € 1.144,00
Antistatic Class M filter / <i>Filtro Classe M Antistatico</i>		M ANT	+ € 113,00
PTFE Antistatic coated Class M filter / <i>Filtro Classe M PTFE Antistatico</i>		PTFE ANT	+ € 502,00
Nomex - heat resistant filter up to 200°C / <i>Filtro resistente al calore fino a 200°C</i>		N	+ € 119,00
(MHD 100 - MHD 130HV - MHD180HV) - 52.500 cm² H14 Absolute filter kit / <i>Filtro assoluto Hepa H14</i>		H14	+ € 750,00
(MHD 130 - MHD150 - MHD200) - 103.000 cm² H14 Absolute filter kit / <i>Filtro assoluto Hepa H14</i>		H14	+ € 995,00
Stainless steel collection tank AISI 304 / <i>Contenitore in acciaio inox AISI 304</i>		X	+ € 890,00
Stainless steel AISI 304 tank and filter chamber / <i>Contenitore e camera in acciaio inox AISI 304</i>		XX	+ € 2.715,00
Earth grounding / <i>Messa a terra</i>		EG	+ € 147,00
Remote control / <i>Avviamento locale da remoto</i>		RC	+ € 237,00
Lifting bracket and ring for container tipping / <i>Staffa per sollevamento a ribaltamento contenitore</i>		TA.0753.3000	+ € 790,00
Abrasion proof plate in Hardox steel for filter chamber <i>Piastra rinforzo in Hardox resistente ad abrasione per bocchettone tangenziale della camera filtrante</i>		HARDOX	+ € 360,00
Recommended accessory / Accessori consigliati		Price / Prezzo / €	
Recommended Ø70 antistatic WD accessory kit / <i>Kit accessori antistatico WD Ø70 consigliato</i>		TA.1041.0000	€ 592,00



Industrial vacuum cleaner, M and MHD range, PN version

An effective filtration system composed of cartridges with a large filtering surface and an innovative, completely automatic pneumatic cleaning system. It's particularly suitable for treating large quantities of very fine powders which can clog filtration systems.

Aspiratori industriali serie M e MHD in versione PN

Un efficace sistema di filtrazione composto da cartucce ad ampia superficie filtrante con un innovativo sistema di pulizia automatico in contro corrente d'aria.

Particolarmente indicato per trattare polveri molto fini e in quantità cospicue che potrebbero precocemente intasare i comuni sistemi di filtrazione.



TECHNICAL DATA / DATI TECNICI		M50 / M50HV	M70 / M90	MHD SERIES
Superficie filtrante / Filter surface	Cm ²	57.000	80.000	106.000
Tipo di filtro / Filter type		3 x Cartridge / Cartucce - h500mm	3 x Cartridge / Cartucce - h700mm	4 x Cartridge / Cartucce - h700mm
Ø filtro / Ø filter	mm.	150		
Media, class / Media, classe (IEC 60335-2-69) ²		Polyester - M ANT		
Cleaning system / Sistema di pulizia		Reverse air pulse automatic filter cleaning system Pneumatico in controcorrente d'aria alternato automatico		

PN Version price / Prezzo versioni PN	Price / Prezzo / €	
M50 PN	M50PN-001	€ 7.008,00
M50 HV PN	M50HVPN-001	€ 7.579,00
M70 PN	M70PN-001	€ 7.638,00
M90 PN	M90PN-001	€ 10.927,00
MHD 100 PN	MHD100PN-001	€ 15.028,00
MHD 130 PN	MHD130PN-001	€ 16.419,00
MHD 130HV PN	MHD130HVPN-001	€ 16.537,00
MHD 150 PN	MHD150PN-001	€ 17.775,00
MHD 180HV PN	MHD180HVPN-001	€ 21.665,00
MHD 200 PN	MHD200PN-001	€ 20.369,00
MHD 250HV PN - NEW	MHD250HVPN-001	€ 23.868,00

Optionals / Opzioni*	Price / Prezzo / €	
Air compressor installed on board / <i>Compressore installato a bordo macchina</i>	COMP	+ € 1.144,00
M Series - PTFE Antistatic coated Class M cartridge filter / <i>Filtro cartuccia Classe M PTFE Antistatico</i>	PTFE ANT	+ € 297,00
MHD Series - PTFE Antistatic coated Class M cartridge filter / <i>Filtro cartuccia Classe M PTFE Antistatico</i>	PTFE ANT	+ € 396,00

* For further optionals please consider standard product version / *Per altre opzioni considerare la versione base del prodotto*

Recommended accessory / Accessori consigliati	Price / Prezzo / €	
(M Series) - Kit accessori WD Ø50 consigliato / <i>Recommended Ø50 WD accessory kit</i>	TA.0617.0000	€ 309,00
(M Series) - Kit accessori Dry Ø50 consigliato / <i>Recommended Ø50 Dry accessory kit</i>	TA.0618.0000	€ 309,00

TA.0617.0000



TA.0618.0000



(MHD Series) - <i>Recommended Ø70 antistatic WD accessory kit / Kit accessori antistatico WD Ø70 consigliato</i>	TA.1041.0000	€ 592,00
---	--------------	----------

TA.1041.0000



Fixed suction unit for direct extraction

Compact suction unit for direct extraction of scraps or dust
 Modular configuration for different purposes
 Maintenance free motor, suitable for continuous duty application
 24/7

Unità di aspirazione fissa a bordo macchina

Unità compatta per estrazioni di sfridi e polveri a bordo macchina
 Configurazione modulare per installazione diretta su macchina e linee di produzione.
 Turbine adatte al servizio continuativo 24/7

TECHNICAL DATA / DATI TECNICI		SK 10	SK 20	SK 30	SK 40
Voltage / Tensione	V - Hz	400 - 50 3~	400 - 50 3~	400 - 50 3~	400 - 50 3~
Power / Potenza	kW	0,85	1,8	2,2	4
Water Lift max. / Depressione max.	mm.H ₂ O	2.000	2.300	3.000	3.200
Air Flow max. / Portata d'aria max.	M ³ /h	150	250	300	450
Filter surface / Superficie filtrante	Cm ²	8.000			
Filter type / Tipo di filtro		Star / Tasche			
Ø filter / Ø filtro	mm.	280			
Media, class / Media, classe (IEC 60335-2-69) ²		Polyester - ANT M			
Tank capacity / Capacità contenitore	Lt.	25			
Tank material / Materiale contenitore		Stainless Steel			
Ø Suction inlet / Ø Bocchettone	mm.	50			
Noise level / Rumorosità (EN ISO 3744)	dB(A)	70		71	73
Dimensions / Dimensioni	cm.	77 x 45 x 60h			
Weight / Peso	kg.	35	41	45	58

Standard version price / Prezzo versioni standard	Price / Prezzo / €	
SK 10	SK10-001	€ 1.505,00
SK 20	SK20-001	€ 1.844,00
SK 30	SK30-001	€ 2.046,00
SK 40	SK40-001	€ 2.522,00

Opzioni / Options	Price / Prezzo / €	
Earth grounding / Messa a terra	EG	+ € 100,00



COMPRESSED AIR INDUSTRIAL VACUUM CLEANERS

ASPIRATORI INDUSTRIALI AD ARIA COMPRESSA

VENTURI DRIVEN SUCTION UNIT



Air Operated Industrial Vacuum

100% Steel construction.

Maintenance free Venturi suction unit

Suitable for wet, dry and dust applications at the same time.

High capacity detachable container with possibility of use disposable bags.

Filter clogging detector and integrated filter cleaning system.

Aspiratore Industriale ad aria compressa

Costruzione 100% acciaio.

Unità di aspirazione Venturi senza necessità alcuna di manutenzione

Possibilità di aspirare contemporaneamente polveri, liquidi e solidi.

Contenitore a sgancio rapido, con possibilità di insaccamento.

Indicatore di intasamento del filtro e sistema di pulizia manuale integrato.

TECHNICAL DATA / DATI TECNICI		WD 3000 AIR 7V	WD 3000 AIR 14V
Suction type / Tipologia aspirazione		Venturi	
Ejectors / Ugelli	n.	7	14
Air supply / Alimentazione aria	nlt/min (nm ³ /h)	729 (43)	1458 (87)
Water Lift max. / Depressione max.	mm.H ₂ O	3.700	3.700
Air Flow max. / Portata d'aria max.	M ³ /h	150	300
Filter surface / Superficie filtrante	Cm ²	8.000	8.000
Filter type / Tipo di filtro		Bag / Sacco	
Ø filter / Ø filtro	mm.	400	
Media, class / Media, classe (IEC 60335-2-69) ²		Polyester - L	
Solids capacity / Capacità solidi	Lt.	60	
Ø Suction inlet / Ø Bocchettone	mm.	50	
Noise level / Rumorosità (EN ISO 3744)	dB(A)	78	
Dimensions / Dimensioni	cm.	72x56x94h	
Weight / Peso	kg.	29	30

Standard version price / Prezzo versioni standard	Price / Prezzo / €	
WD 3000 AIR 7V	WD3000AIR7V-001	€ 1.960,00
WD 3000 AIR 14V	WD3000AIR14V-001	€ 2.450,00

Recommended accessory / Accessori consigliati	Price / Prezzo / €	
Recommended Ø40 WD accessory kit / Kit accessori WD Ø40 consigliato	TA.0615.0000	€ 203,00
Recommended Ø40 Dry accessory kit / Kit accessori Dry Ø40 consigliato	TA.0616.0000	€ 203,00



Air Operated Industrial Vacuum

100% Steel construction.
 Maintenance free Venturi suction unit
 Suitable for wet, dry and dust applications at the same time.
 High capacity detachable container with possibility of use disposable bags.
 Filter clogging detector and integrated filter cleaning system.

Aspiratore Industriale ad aria compressa

Costruzione 100% acciaio.
 Unità di aspirazione Venturi senza necessità alcuna di manutenzione
 Possibilità di aspirare contemporaneamente polveri, liquidi e solidi.
 Contenitore a sgancio rapido, con possibilità di insaccamento.
 Indicatore di intasamento del filtro e sistema di pulizia manuale integrato.

TECHNICAL DATA / DATI TECNICI		W1 AIR
Suction type / Tipologia aspirazione		Venturi
Ejectors / Ugelli	n.	7
Air supply / Alimentazione aria	nlt/min (nm ³ /h)	729 (43)
Water Lift max. / Depressione max.	mm.H ₂ O	3.700
Air Flow max. / Portata d'aria max.	M ³ /h	150
Filter surface / Superficie filtrante	Cm ²	8.000
Filter type / Tipo di filtro		Star / Tasche
Ø filter / Ø filtro	mm.	280
Media, class / Media, classe (IEC 60335-2-69) ²		Polyester - L*
Solids capacity / Capacità solidi	Lt.	15
Noise level / Rumorosità (EN ISO 3744)	dB(A)	78
Dimensions / Dimensioni	cm.	43x40x96h
Weight / Peso	kg.	25

*For other filter medias available please consult the W1 options pag.16. / Per altri media filtranti disponibili vedi W1 a pag. 16.

Standard version price / Prezzo versioni standard	Price / Prezzo / €	
W1 AIR 7V	W1AIR7V-001	€ 1.870,00

Recommended accessory / Accessori consigliati	Price / Prezzo / €	
Recommended Ø32 WD accessory kit / Kit accessori WD Ø32 consigliato	TA.1156.0000	€ 145,00

TA.1156.0000



Air Operated Industrial Vacuum

100% Steel construction.

Maintenance free Venturi suction unit

Suitable for wet, dry and dust applications at the same time.

High capacity detachable container with possibility of use disposable bags.

Filter clogging detector and integrated filter cleaning system.

Aspiratore Industriale ad aria compressa

Costruzione 100% acciaio.

Unità di aspirazione Venturi senza necessità alcuna di manutenzione

Possibilità di aspirare contemporaneamente polveri, liquidi e solidi.

Contenitore a sgancio rapido, con possibilità di insaccamento.

Indicatore di intasamento del filtro e sistema di pulizia manuale integrato.



TECHNICAL DATA / DATI TECNICI		W2 AIR 7V	W2 AIR 14V
Suction type / Tipologia aspirazione		Venturi	
Ejectors / Ugelli	n.	7	14
Air supply / Alimentazione aria	nlt/min (nm ³ /h)	729 (43)	1458 (87)
Water Lift max. / Depressione max.	mm.H ₂ O	3.700	3.700
Air Flow max. / Portata d'aria max.	M ³ /h	150	300
Filter surface / Superficie filtrante	Cm ²	20.000	
Filter type / Tipo di filtro		Star / Tasche	
Ø filter / Ø filtro	mm.	420	
Media, class / Media, classe (IEC 60335-2-69) ²		Polyester - L*	
Solids capacity / Capacità solidi	Lt.	40	
Ø Suction inlet / Ø Bocchettone	mm.	50	
Noise level / Rumorosità (EN ISO 3744)	dB(A)	78	
Dimensions / Dimensioni	cm.	63x57x108h	
Weight / Peso	kg.	42	43

*For other filter medias available please consult the W2 options pag.14 / Per altri media filtranti disponibili vedi W2 a pag. 14

Standard version price / Prezzo versioni standard	Price / Prezzo / €	
W2 AIR 7V	W2AIR7V-001	€ 2.155,00
W2 AIR 14V	W2AIR14V-001	€ 3.100,00

Recommended accessory / Accessori consigliati	Price / Prezzo / €	
Recommended Ø40 WD accessory kit / Kit accessori WD Ø40 consigliato	TA.0615.0000	€ 203,00
Recommended Ø40 Dry accessory kit / Kit accessori Dry Ø40 consigliato	TA.0616.0000	€ 203,00



Air Operated Industrial Vacuum

100% Steel construction.

Suitable for wet, dry and dust applications at the same time. Maintenance free Venturi suction unit with 19 or 25 nozzles. High capacity detachable container with possibility of use disposable bags.

Large filter surface with integrated filter cleaning system.

Aspiratore Industriale ad aria compressa

Costruzione 100% acciaio.

Possibilità di aspirare contemporaneamente polveri, liquidi e solidi. Unità di aspirazione Venturi a 19 o 25 ugelli senza necessità alcuna di manutenzione.

Contenitore a sgancio rapido, con possibilità di insaccamento. Filtro di ampia superficie per polveri fini con sistema di pulizia manuale integrato.

TECHNICAL DATA / DATI TECNICI		W 3 AIR 19	W 3 AIR 25
Suction Type / Tipologia aspirazione		Multi Ejectors Venturi	
Ejectors / Ugelli	nr.	19	25
Air supply / Alimentazione aria	nlt/min (nm ³ /h)	1.530 (92)	2.500 (150)
Water Lift max. / Depressione max.	mm.H ₂ O	5.000	5.000
Air Flow max. / Portata d'aria max.	M ³ /h	465	590
Filter surface / Superficie filtrante	Cm ²	20.000	
Filter type / Tipo di filtro		Star / Tasche	
Ø filter / Ø filtro	mm.	420	
Media, class / Media, classe (IEC 60335-2-69) ²		Polyester - L*	
Solids capacity / Capacità solidi	Lt.	65/100	
Ø Suction inlet / Ø Bocchettone	mm.	80	
Noise level / Rumorosità (EN ISO 3744)	dB(A)	79	
Dimensions / Dimensioni	cm.	70x62x134h	
Weight / Peso	kg.	65	66

*For other filter medias available please consult the W3 options pag.17 / Per altri media filtranti disponibili vedi W3 a pag. 17

Standard version price / Prezzo versioni standard	Price / Prezzo / €	
W 3 AIR 19 - 65lt	W3AIR19-001	€ 4.205,00
W 3 AIR 25 - 65lt	W3AIR25-001	€ 5.490,00
W 3 AIR 19 - 100lt	W3AIR19-002	€ 4.325,00
W 3 AIR 25 - 100lt	W3AIR25-002	€ 5.605,00

Optionals / Opzioni	Price / Prezzo / €	
Configuration for discharging on grid or container Predisposizione per scarico su grigliato o contenitore		GD Upon Request

Recommended accessory / Accessori consigliati	Price / Prezzo / €	
Recommended Ø50 WD accessory kit / Kit accessori WD Ø50 consigliato	TA.0617.0000	€ 309,00
Recommended Ø50 Dry accessory kit / Kit accessori Dry Ø50 consigliato	TA.0618.0000	€ 309,00

TA.0617.0000



TA.0618.0000



SILOS & VAC

FILTERING SILOS, VACUUMING SILOS & CENTRAL VACUUM UNIT FOR CENTRAL VACUUM SYSTEM
SILOS FILTRANTI, SILOS ASPIRANTI E CENTRALI ASPIRANTI PER SISTEMI DI ASPIRAZIONE CENTRALIZZATI

VACUUMING SILOS



FILTERING SILOS



CENTRAL VACUUM UNIT



Vacuuming SILOS: the highest expression of DU-PUY Flexibility

Designed for large quantities of materials and direct discharge into big-collection baskets.

Collection capacity of 100lt.

Material discharge with tilting flap, butterfly valves, guillotine.

Simplified and fast BIG-BAG bagging system.

High surface dust filter for fine dust with manual shaker.

Mounted on wheels or fixed on the floor.

Sturdy chassis and forklift intakes.

SILOS Aspiranti: la massima espressione di Flessibilità DU-PUY

Concepiti per l'aspirazione di grosse quantità di materiali e scarico diretto in big-bag o fusti di raccolta.

Capacità di raccolta da 100 lt.

Scarico materiale con valvole a farfalla, ghigliottine, paletta bilanciata.

Insaccamento in BIG-BAG semplificato e rapido.

Filtro ad elevata superficie per polveri fini, dotato di scuotitore manuale.

Montati su ruote o fissi a pavimento.

Telaio inforcabile con muletto di serie.

TECHNICAL DATA / DATI TECNICI		SILOVAC 100	SILOVAC 100T
Voltage / Tensione	V - Hz	230 - 50 1~	400 - 50 3~
Power / Potenza	kW	3 x 1,1**	3
Water Lift max. / Depressione max.	mm.H ₂ O	2.400	2.600
Air Flow max. / Portata d'aria max.	M ³ /h	540	370
Filter surface / Superficie filtrante	Cm ²	20.000	
Filter type / Tipo di filtro		Star / Tasche	
Ø filter / Ø filtro	mm.	420	
Media, class / Media, classe (IEC 60335-2-69) ²		Polyester - L*	
Tank capacity / Capacità contenitore	Lt.	100	
Ø Suction inlet / Ø Bocchettone	mm.	80	
Noise level / Rumorosità (EN ISO 3744)	dB(A)	78	72
Discharge system / Sistema di scarico		Butterfly valve Ø150 / Valvola a farfalla Ø150***	
Silos chassis type / Tipologia chassis		Big-bag chassis / Chassis per scarico in big-bag	
Dimensions / Dimensioni	cm.	139x126x294h	139x126x315h
Weight / Peso	kg.	160	170

Standard version price / Prezzo versioni standard	Price / Prezzo / €	
SILOVAC 100	SILOVAC100-001	€ 5.700,00
SILOVAC 100T	SILOVAC100T-001	€ 6.405,00

Special version price / Prezzo versioni speciali	Price / Prezzo / €	
SILOVAC 100 Wall mounted / Fisso a parete		€ 4.710,00
SILOVAC 100T Wall mounted / Fisso a parete		€ 5.415,00
SILOVAC 100 For discharging on the floor, hopper capacity 90lt, discharge height from the ground 100mm / Per scarico a pavimento, capacità tramoggia 90lt altezza scarico dal suolo 100mm		€ 4.930,00
SILOVAC 100T For discharging on the floor, hopper capacity 90lt, discharge height from the ground 100mm / Per scarico a pavimento, capacità tramoggia 90lt altezza scarico dal suolo 100mm		€ 5.335,00

*For other filter medias available please consult the W3 options pag.17 / Per altri media filtranti disponibili vedi W3 a pag. 17.

** HV 3 motors with three stages 3 x 1,3 kW version available / Disponibile in versione HV a 3motori a tre stadi 3 x 1,3 kW.

*** For other discharge systems and level detector options, please consult CVS section pag.135 / Per sistemi di scarico e sonde di livello disponibili, consultare sezione CVS a pag.135



Vacuuming SILOS: the highest expression of DU-PUY Flexibility

Silovac 100 High vacuum with automatic discharge system.
 Designed for large quantities of materials and direct discharge into big-collection baskets.
 Collection capacity of 100lt.
 Material discharge with tilting flap D250.
 Elettrical control panel for automatic management of the system with adjustable timers for material loading and unloading cycle.
 Simplified and fast BIG-BAG bagging system.
 High surface dust filter for fine dust with manual shaker.
 Mounted on wheels or fixed on the floor.
 Sturdy chassis and forklift intakes.

SILOS Aspiranti: la massima espressione di Flessibilità DU-PUY

Silovac 100 High vacuum con sistema di scarico automatico
 Concepito per l'aspirazione di grosse quantità di materiali e scarico diretto in big-bag o fusti di raccolta.
 Capacità di raccolta da 100 lt.
 Scarico materiale con paletta bilanciata D250.
 Pannello elettrico di controllo per gestione automatica del sistema con timer regolabili per il ciclo di carico e scarico.
 Insaccamento in BIG-BAG semplificato e rapido.
 Filtro ad elevata superficie per polveri fini, dotato di scuotitore manuale. Montati su ruote o fissi a pavimento.
 Telaio inforcabile con muletto di serie.

TECHNICAL DATA / DATI TECNICI		SILOVAC 100 HV AD
Voltage / Tensione	V - Hz	230 - 50 1~
Power / Potenza	kW	2 x 1,6
Water Lift max. / Depressione max.	mm.H ₂ O	3600
Air Flow max. / Portata d'aria max.	M ³ /h	340
Filter surface / Superficie filtrante	Cm ²	20.000
Filter type / Tipo di filtro		Star / Tasche
Ø filter / Ø filtro	mm.	420
Media, class / Media, classe (IEC 60335-2-69)*		Polyester - L
Tank capacity / Capacità contenitore	Lt.	100
Ø Suction inlet / Ø Bocchettone	mm.	80
Noise level / Rumorosità (EN ISO 3744)	dB(A)	78
Discharge system / Sistema di scarico		Balanced flap Ø250 / Paletta bilanciata Ø250
Silos chassis type / Tipologia chassis		Big-bag chassis / Chassis per scarico in big-bag
Dimensions / Dimensioni	cm.	139x126x294h
Weight / Peso	kg.	160

Standard version price / Prezzo versioni standard		Price / Prezzo / €
SILOVAC 100 HV Automatic discharge	SILOVAC100HVAD-001	€ 7.055,00
SILOVAC 100 HV Automatic discharge without frame	SILOVAC100HVAD-002	€ 5.735,00
Special version price / Prezzo versioni speciali		Price / Prezzo / €
SILOVAC 100 Wall mounted / Fisso a parete		€ 6.075,00

Performance chart productivity/Tabella di prestazioni			
Distance/Distanza (m)	15	10	5
Flow rate/ Portata (kg/h)	500	750	1000

* Materials with densities between 0.5 and 0.9 kg/lt. / Materiali con densità compresa tra 0,5 e 0,9 kg/lt.

* Necessary use of fluidized lance for aspiration / Necessario utilizzo di lancia fluidificata per aspirazione.

* For other filter medias available please consult the W3 options pag.17 / Per altri media filtranti disponibili vedi W3 a pag. 17.



NEW

Vacuuming SILOS: the highest expression of DU-PUY Flexibility

Designed for large quantities of materials and direct discharge into big-collection baskets.

Collection capacity of 600lt.

Material discharge with butterfly valves.

Discharge into big-bags or big-collection baskets.

High surface dust filter for fine dust with manual filter shaker.

Mounted on chassis for easy transport.

Sturdy chassis and forklift intakes.

SILOS Aspirante professionale

Concepito per l'aspirazione di grosse quantità di materiali e scarico diretto in big-bag o fusti di raccolta.

Capacità di raccolta da 600 lt.

Scarico materiale con valvola a farfalla.

Insaccamento in BIG-BAG semplificato e rapido.

Filtri ad elevate superficie per polveri fini dotato di scuotifiltro manuale.

Telaio su ruote per facile movimentazione.

Telaio inforcabile con muletto di serie.

TECHNICAL DATA / DATI TECNICI		SILOVAC 600 PRO
Voltage / Tensione	V - Hz	400 - 50 3~
Power / Potenza	kW	7,5
Water Lift max. / Depressione max.	mm.H ₂ O	4.000
Continous Waterlift / Depressione in continuo	mm.H ₂ O	2.700
Air Flow max. / Portata d'aria max.	M ³ /h	700
Filter surface / Superficie filtrante	Cm ²	50.000
Filter type / Tipo di filtro		Star / Tasche
Ø filter / Ø filtro	mm.	560
Media, class / Media, classe (IEC 60335-2-69) ²		L
Cleaning system / Sistema di pulizia filtro		Manual Shaker / Scuotifiltro manuale
Tank capacity / Capacità contenitore	Lt.	600
Ø Suction inlet / Ø Bocchettone	mm.	80
Noise level / Rumorosità (EN ISO 3744)	dB(A)	77
Discharge system / Sistema di scarico		Manual butterfly valve Ø250 / Valvola a farfalla manuale Ø250
Silos chassis type / Tipologia chassis		Big-bag chassis / Chassis per scarico in big-bag
Dimensions / Dimensioni	cm.	147x108x350h
Weight / Peso	kg.	500

Standard version price / Prezzo versioni standard	Price / Prezzo / €	
SILOVAC 600 PRO	SILOVAC600PRO-001	€ 16.357,00

Optionals / Opzioni*	Price / Prezzo / €	
Antistatic Class M filter / Filtro Classe M Antistatico	M ANT	+ € 104,00
PTFE Antistatic coated Class M filter / Filtro Classe M PTFE Antistatico	PTFE ANT	+ € 495,00

*For other discharge systems and level detector options, please consult CVS section pag.135

Per sistemi di scarico e sonde di livello disponibili, consultare sezione CVS a pag.135

SILOVAC 600 - SILOVAC 600 AF - SILOVAC 600HV



Vacuating SILOS: the highest expression of DU-PUY Flexibility

Designed for large quantities of materials and direct discharge into big-collection baskets.

Collection capacity of 600lt with maximum level detector.

Material discharge with tilting flap, butterfly valves, guillotine.

Discharge into big-bags or big-collection baskets.

High surface dust filter for fine dust with automatic shaker and compressor.

Mounted on telescopic chassis for easy transport.

Sturdy chassis and forklift intakes.

SILOS Aspiranti: la massima espressione di Flessibilità DU-PUY

Concepiti per l'aspirazione di grosse quantità di materiali e scarico diretto in big-bag o fusti di raccolta.

Capacità di raccolta da 600 lt con sonda di massimo livello.

Scarico materiale con valvole a farfalla, ghigliottine, paletta bilanciata.

Insaccamento in BIG-BAG semplificato e rapido.

Filtri ad elevate superficie per polveri fini dotato di scuotitore automatico e compressore a bordo macchina.

Montati su telaio telescopico per facile movimentazione.

Telaio inforcabile con muletto di serie.

TECHNICAL DATA / DATI TECNICI		SILOVAC 600	SILOVAC 600AF	SILOVAC 600HV
Voltage / Tensione	V - Hz	400 - 50 3~	400 - 50 3~	400 - 50 3~
Power / Potenza	kW	12,5	18,5	20
Water Lift max. / Depressione max.	mm.H ₂ O	4.400	4.400	6.000
Continous Waterlift / Depressione in continuo	mm.H ₂ O	2.900	3.200	4.500
Air Flow max. / Portata d'aria max.	M ³ /h	1.100	1.350	1.100
Filter surface / Superficie filtrante	Cm ²	70.000		
Filter type / Tipo di filtro		Star / Tasche		
Ø filter / Ø filtro	mm.	560		
Media, class / Media, classe (IEC 60335-2-69) ²		M PTFE ANT		
Cleaning system / Sistema di pulizia filtro		Automatic self clean with included compressor Automatico con compressore a bordo incluso		
Safety filter / Filtro di sicurezza		Cartridge H14 52.000 cm ² / Cartuccia Hepa H14 52.000 cm ²		
Tank capacity / Capacità contenitore	Lt.	600		
Level detector / Sonda di livello massimo		Rotary level detector / Sonda di livello rotante		
Ø Suction inlet / Ø Bocchettone	mm.	100		
Noise level / Rumorosità (EN ISO 3744)	dB(A)	76	81	79
Discharge system / Sistema di scarico		Manual butterfly valve Ø250 / Valvola a farfalla manuale Ø250		
Silos chassis type / Tipologia chassis		Telescopic big-bag chassis Chassis per scarico in big-bag telescopico		
Dimensions / Dimensioni	cm.	Low position 135x135x250h - Highest position 135x135x400h		
Weight / Peso	kg.	1015	1025	1125

Standard version price / Prezzo versioni standard	Price / Prezzo / €	
SILOVAC 600	SILOVAC600-001	€ 29.156,00
SILOVAC 600AF	SILOVAC600AF-001	€ 31.742,00
SILOVAC 600HV	SILOVAC600HV-001	€ 36.507,00

Optionals / Opzioni*	Price / Prezzo / €	
Remote Control / Avviamento locale remoto	RC	+ € 237,00
Radio control (Start and Stop) including 2 remotes Avviamento da distanza con radiocomando	RRC	+ € 1.140,00



*For other discharge systems and level detector options, please consult CVS section pag.135

Per sistemi di scarico e sonde di livello disponibili, consultare sezione CVS a pag.135

Filtering SILOS: the highest expression of DU-PUY Flexibility.

Connected to a CVAC unit, they are designed for suction of large quantities of materials and direct discharge into big-bags or collection baskets.

Collection capacity from 200 to 1000lt.

Direct connection with Central vacuum unit from 5,5 up to 25kW. Material discharge with tilting flap, butterfly valves, guillotine, rotovalve. Simplified and fast BIG-BAG bagging system.

High surface dust filter for fine dust with manual shaker. Mounted on wheels or fixed to the floor. Sturdy chassis and forklift intakes.

SILOS filtranti: la massima espressione di flessibilità DU-PUY.

Connessi a una potente centrale aspirante sono concepiti per l'aspirazione di grosse quantità di materiali e scarico diretto in big-bag o fusti di raccolta. Capacità di raccolta da 200 a 1000lt.

Possibilità di connessione a turbine canale laterale da 5,5 a 25kW di potenza.

Scarico materiale con porta basculante, valvole a farfalla, ghigliottine o rotovalle. Insaccamento in BIG-BAG semplificato e rapido.

Filtro ad elevata superficie per polveri fini dotato di scuotitore manuale. Montati su ruote o fissi. Telaio inforcabile con muletto di serie.



TECHNICAL DATA / DATI TECNICI		SILOFILTER200 SILOFILTER600 SILOFILTER1000		
Filter surface / Superficie filtrante	Cm ²	50.000*		
Filter type / Tipo di filtro		Star / Tasche		
Ø filter / Ø filtro	mm.	560		
Media, class / Media, classe (IEC 60335-2-69) ²		Polyester - L**	Polyester - L	
Tank capacity / Capacità contenitore	Lt.	200	600	1000
Ø Suction inlet / Ø Bocchettone	mm.	80		
Discharge system / Sistema di scarico		Open Flange Ø150/ Flangia Ø150	Open Flange Ø250 / Flangia aperta Ø250	
Silos chassis type / Tipologia chassis /		Big-bag chassis / Chassis per scarico in big-bag		
Dimensions / Dimensioni	cm.	143x99x355h	147x108x350h	147x108x400h
Weight / Peso	kg.	290	348	390

* Different filtering surfaces available, base on the CVAC unit choosen / Differenti superfici filtranti disponibili a richiesta

**For other filter medias available please consult the W3 options pag. 17 / Per altri media filtranti disponibili vedi W3 a pag. 17.

Standard version price / Prezzo versioni standard	Price / Prezzo / €	
SILOFILTER 200	SILOFILTER200-001	€ 5.440,00
SILOFILTER 600	SILOFILTER600-001	€ 8.460,00
SILOFILTER 1000	SILOFILTER1000-001	€ 10.110,00

Options available upon request / Opzioni su richiesta *	Price / Prezzo / €	
CAT ANT M - Star filter 50.000cm ² / Filtro a tasche 50.000cm ²	ANT M	+ € 104,00
CAT M ANT PTFE - Star filter 50.000cm ² / Filtro a tasche 50.000cm ²	ANT PTFE	+ € 495,00
(SILOFILTER 600-1000) CAT L - Star filter 70.000cm ² / Filtro a tasche 70.000cm ²	ELF L	+ € 380,00
(SILOFILTER 600-1000) CAT M ANT - Star filter 70.000cm ² / Filtro a tasche 70.000cm ²	ELF M ANT	+ € 493,00
(SILOFILTER 600-1000) CAT M ANT PTFE - Star filter 70.000cm ² / Filtro a tasche 70.000cm ²	ELF ANT PTFE	+ € 931,00
Automatic filter shaker with pneumatic Cylinder with Timer and Push Button Scuotifiltro automatico temporizzato con cilindro pneumatico ad aria compressa**	 AUT	+ € 2.044,00
Wheels set / Set ruote		On Request

*For other discharge systems and level detector options, please consult CVS section pag.135

Per sistemi di scarico e sonde di livello disponibili, consultare sezione CVS a pag.135

**Surcharge valid for electrical management by electric panel Δ / Y / Maggiorazione valida per gestione elettrica da quadro elettrico Δ / Y

SILOFILTER 200PN - SILOFILTER 600PN - SILOFILTER 1000PN



Filtering SILOS: the highest expression of DU-PUY Flexibility.

Connected to a CVAC unit, they are designed for suction of large quantities of materials and direct discharge into big-bags or collection baskets. Collection capacity from 200 to 1000lt. Direct connection with Central vacuum unit from 5,5 up to 25kW. Material discharge with tilting flap, butterfly valves, guillotine, rotovalve. Simplified and fast BIG-BAG bagging system. High surface dust filter for fine dust with automatic filter cleaning system. Mounted on wheels or fixed to the floor. Sturdy chassis and forklift intakes.

SILOS filtranti: la massima espressione di flessibilità DU-PUY.

Connessi a una potente centrale aspirante sono concepiti per l'aspirazione di grosse quantità di materiali e scarico diretto in big-bag o fusti di raccolta. Capacità di raccolta da 200 a 1000lt. Possibilità di connessione a turbine canale laterale da 5,5 a 25kW di potenza. Scarico materiale con porta basculante, valvole a farfalla, ghigliottine o rotocella. Insaccamento in BIG-BAG semplificato e rapido. Filtro ad elevata superficie per polveri fini dotato di filtri autopulenti montati su ruote o fissi a pavimento. Telaio inforcabile con muletto di serie.

TECHNICAL DATA / DATI TECNICI		SILOFILTER 200PN	SILOFILTER 600PN	SILOFILTER 1000PN
Filter type / Tipo di filtro		Cartridge / Cartuccia		
Filter surface / Superficie filtrante	cm ²	106.000		
Cartridges n° / Numero cartucce		4		
Filter / filtro	mm.	Ø150 x h700		
Media, class / Media, classe (IEC 60335-2-69) ²		M ANT		
Cleaning system / Sistema di pulizia filtro		Self clean Auto pulente		
Tank capacity / Capacità contenitore	Lt.	200	600	1000
Ø Suction inlet / Ø Bocchettone	mm.	80		
Discharge system / Sistema di scarico		Open Flange Ø150/ Flangia aperta Ø150	Open Flange Ø250 / Flangia aperta Ø250	
Silos chassis type / Tipologia chassis /		Big-bag chassis / Chassis per scarico in big-bag		
Dimensions / Dimensioni	cm.	143x99x375h	147x108x359h	147x108x390h
Weight / Peso	kg.	330	395	440

Standard version price / Prezzo versioni standard	Price / Prezzo / €	
SILOFILTER 200PN	SILOFILTER200-005	€ 8.285,00
SILOFILTER 600PN	SILOFILTER600-002	€ 11.415,00
SILOFILTER 1000PN	SILOFILTER1000-002	€ 13.060,00

Options available upon request / Opzioni su richiesta	Price / Prezzo / €	
Cartridge filters Cat. M Antistatic PTFE / Filtri a cartuccia Cat. M Antistatica PTFE	ANT PTFE	+ € 457,00

*For other discharge systems and level detector options, please consult CVS section pag.135
Per sistemi di scarico e sonde di livello disponibili, consultare sezione CVS a pag.135

Filtering SILOS: the highest expression of DU-PUY Flexibility.

Connected to a CVAC unit, they are designed for suction of large quantities of materials and direct discharge into big-bags or collection baskets. Collection capacity from 160 to 250lt. Direct connection with Central vacuum unit from 4 up to 25kW. Material discharge with tilting flap, butterfly valves, guillotine, rotovalve.

Simplified and fast BIG-BAG bagging system.

High surface filtering sleeves for fine dust with automatic filter cleaning system. Sturdy chassis and forklift intakes.

SILOS filtranti: la massima espressione di flessibilità DU-PUY.

Connessi a una potente centrale aspirante sono concepiti per l'aspirazione di grosse quantità di materiali e scarico diretto in big-bag o fusti di raccolta. Capacità di raccolta da 160 a 250lt. Possibilità di connessione a turbine canale laterale da 4 a 25kW di potenza. Scarico materiale con porta basculante, valvole a farfalla, ghigliottine o rotocecella.

Insaccamento in BIG-BAG semplificato e rapido.

Filtri a maniche ad elevata superficie per polveri fini dotati di sistema autopulente. Telaio inforcabile con muletto di serie.

TECHNICAL DATA / DATI TECNICI		BAGFILTER 160	SILOBAG 250 FILTER
Filter surface / Superficie filtrante	Cm ²	60.000	
Filter type / Tipo di filtro		Round bags sleeves Maniche a sacco	
Ø filter / Ø filtro	mm.	800	
Media, class / Media, classe (IEC 60335-2-69) ²		M ANT Teflon Hydro-Oleophobic	
Cleaning system / Sistema di pulizia filtro		Automatic PN / Automatico PN in controcorrente d'aria	
Tank capacity / Capacità contenitore	Lt.	160	250
Ø Suction inlet / Ø Bocchettone	mm.	120	
Discharge system / Sistema di scarico		Collector tank / Contenitore	Open Flange Ø250 / Flangia aperta Ø250
Silos chassis type / Tipologia chassis		Collector tank / Contenitore	Big-bag chassis / Chassis per scarico in big-bag
Dimensions / Dimensioni	cm.	101x96x240h	143x99x369h
Standard version price / Prezzo versioni standard*		Price / Prezzo / €	
BAGFILTER 160		€ 13.717,00	
SILOBAG 250 FILTER		€ 16.216,00	

*For other discharge systems and level detector options, please consult CVS section pag.135

Per sistemi di scarico e sonde di livello disponibili, consultare sezione CVS a pag.135

SILOBAG 600 FILTER - SILOBAG 1000 FILTER



Filtering SILOS: the highest expression of DU-PUY Flexibility.

Connected to a CVAC unit, they are designed for suction of large quantities of materials and direct discharge into big-bags or collection baskets. Collection capacity from 600 to 1000lt. Direct connection with Central vacuum unit from 4 up to 25kW. Material discharge with tilting flap, butterfly valves, guillotine, rotovalve.

Simplified and fast BIG-BAG bagging system.

High surface dust filter for fine dust with automatic filter cleaning system.

Sturdy chassis and forklift intakes.

SILOS filtranti: la massima espressione di flessibilità DU-PUY.

Connessi a una potente centrale aspirante sono concepiti per l'aspirazione di grosse quantità di materiali e scarico diretto in big-bag o fusti di raccolta. Capacità di raccolta da 600 a 1000lt. Possibilità di connessione a turbine canale laterale da 4 a 25kW di potenza.

Scarico materiale con porta basculante, valvole a farfalla, ghigliottine o rotoceffa.

Insaccamento in BIG-BAG semplificato e rapido.

Filtro ad elevata superficie per polveri fini dotato di sistema autopulente.

Telaio inforcabile con muletto di serie.

TECHNICAL DATA / DATI TECNICI		SILOBAG 600 FILTER	SILOBAG 1000 FILTER
Filter surface / Superficie filtrante	Cm ²	60.000	110.000
Filter type / Tipo di filtro		Round bags sleeves Maniche a sacco	
Ø filter / Ø filtro	mm.	800	1000
Media, class / Media, classe (IEC 60335-2-69) ²		M ANT Teflon Hydro-Oleophobic	
Cleaning system / Sistema di pulizia filtro		Automatic PN / Automatico PN in controcorrente d'aria	
Tank capacity / Capacità contenitore	Lt.	600	1000
Ø Suction inlet / Ø Bocchettone	mm.	80 / 120 / 160	
Discharge system / Sistema di scarico		Open Flange Ø250 / Flangia aperta Ø250	
Silos chassis type / Tipologia chassis		Big-bag chassis / Chassis per scarico in big-bag	
Dimensions / Dimensioni	cm.	147x108x369h	147x108x386h

Standard version price / Prezzo versioni standard	Price / Prezzo / €
SILOBAG 600 FILTER	€ 18.987,00
SILOBAG 1000 FILTER	€ 23.783,00

*For other discharge systems and level detector options, please consult CVS section pag.135

Per sistemi di scarico e sonde di livello disponibili, consultare sezione CVS a pag.135

Central vacuum units with side channel blowers.

From 4 to 7,5 kW.

Side channel blower and protective carter.

A pressure relief valve is equipped as standard.

CVAC 50 Direct starting, 24 Volt controls and L/R.

CVAC 70 - CVAC 90 Δ / Y starting, 24 Volt controls and L/R.

The price includes the electrical panel.

Centrali aspiranti con turbine a canale laterale.

Da 4 a 7,5 kW.

Pompa di Vuoto a Canale Laterale, Carter di protezione.

Dotati di Valvola limitatrice di vuoto di serie.

CVAC 50 Avviamento diretto, comandi 24 Volt e L/R.

CVAC 70 - CVAC 90 Avviamento Δ / Y, comandi 24 Volt e L/R.

Il quadro elettrico è incluso nel prezzo.

TECHNICAL DATA / DATI TECNICI		CVAC 50	CVAC 70	CVAC 90
Voltage / Tensione	V - Hz	400 - 50 3~	400 - 50 3~	400 - 50 3~
Power / Potenza	kW	4	5,5	7,5
Waterlift max. / Depressione max.	mm.H ₂ O	3.200	3.600	3.200
Continous Waterlift / Depressione in continuo	mm.H ₂ O	2.600	3.000	2.700
Air Flow max. / Portata d'aria max.	M ³ /h	420	530	700
Suction inlet / Bocchettone	mm	60	70	
Noise level / Rumorosità (EN ISO 3744)	dB(A)	74	74	77
Dimensions / Dimensioni	cm.	67x63x131h		

Included: electric panel board, pressure relief valve, selector for remote start/stop, noise silencer

Incluso: quadro elettrico, valvola limitatrice di vuoto, settore locale/remoto, silenziatore

Standard version price / Prezzo versioni standard	Price / Prezzo / €	
CVAC 50	CVAC50-001	€ 4.609,00
CVAC 70	CVAC70-001	€ 5.368,00
CVAC 90	CVAC90-001	€ 7.002,00

Options available upon request / Opzioni su richiesta	Price / Prezzo / €	
Additional silencer / Silenziatore supplementare - Ø90 h535	ADD/SIL	+ € 162,00
Inverter	INV	On Request

Central vacuum units with side channel blowers.

From 7,5 to 18,5 kW.

Side channel blower and protective carter.

A pressure relief valve is equipped as standard.

Electrical panel with direct starting, 24 Volt controls and L/R.

The price includes the electrical panel.

Centrali aspiranti con turbine a canale laterale.

Da 7,5 a 18,5 kW.

Pompa di Vuoto a Canale Laterale, Carter di protezione.

Dotati di Valvola limitatrice di vuoto di serie.

Pannello elettrico con avviamento diretto, comandi 24 Volt e L/R.

Il quadro elettrico è incluso nel prezzo.

TECHNICAL DATA / DATI TECNICI		CVAC 100	CVAC 130	CVAC 150	CVAC 200
Voltage / Tensione	V - Hz	400 - 50 3~	400 - 50 3~	400 - 50 3~	400 - 50 3~
Power / Potenza	kW	7,5	11	12,5	18,5
Waterlift max. / Depressione max.	mm.H ₂ O	4.500	4.000	4.000	4.000
Continuous Waterlift / Depressione in continuo	mm.H ₂ O	3.200	2.600	2.900	3.200
Air Flow max. / Portata d'aria max.	M ³ /h	750	1.050	1.100	1.350
Suction inlet / Bocchettone	mm	100	100	100	100
Noise level / Rumorosità (EN ISO 3744)	dB(A)	74	75	76	81
Dimensions / Dimensioni	cm.	89x78x124h			

Included: electric panel board, pressure relief valve, selector for remote start/stop, noise silencer

Incluso: quadro elettrico, valvola limitatrice di vuoto, settore locale/remoto, silenziatore

Standard version price / Prezzo versioni standard	Price / Prezzo / €	
CVAC 100	CVAC100-001	€ 9.955,00
CVAC 130 - NEW	CVAC130-001	€ 10.054,00
CVAC 150	CVAC150-001	€ 11.011,00
CVAC 200	CVAC200-001	€ 13.750,00

Options available upon request / Opzioni su richiesta	Price / Prezzo / €	
CVAC 100 - In/Out Ø100 Safety cartridge HEPA H14 filter / Filtro di sicurezza HEPA H14 - 52.000cm ² 	H14	+ € 1.012,00
CVAC 130 - CVAC 150 - CVAC 200 - In/Out Ø100 Safety cartridge HEPA H14 filter / Filtro di sicurezza HEPA H14 - 103.000cm ² 	H14	+ € 1.288,00
Additional silencer / Silenziatore supplementare	ADD/SIL	+ € 304,00
Inverter	INV	On Request

Central vacuum units with side channel blowers.

25 kW.

Side channel blower and protective carter.

A pressure relief valve is equipped as standard.

Electrical panel with direct starting, 24 Volt controls and L/R.

The price includes the electrical panel.

Centrali aspiranti con turbine a canale laterale.

Da 20 a 25 W.

Pompa di Vuoto a Canale Laterale, Carter di protezione.

Dotati di Valvola limitatrice di vuoto di serie.

Pannello elettrico con avviamento diretto, comandi 24 Volt e L/R.

Il quadro elettrico è incluso nel prezzo.

TECHNICAL DATA / DATI TECNICI		CVAC 300
Voltage / Tensione	V - Hz	400 - 50 3~
Power / Potenza	kW	25
Waterlift max. / Depressione max.	mm.H ₂ O	4.500
Continous Waterlift / Depressione in continuo	mm.H ₂ O	3.200
Air Flow max. / Portata d'aria max.	M ³ /h	2.050
Suction inlet / Bocchettone	mm	130
Noise level / Rumorosità (EN ISO 3744)	dB(A)	79
Dimensions / Dimensioni	cm.	103x93x197h

Included: electric panel board, pressure relief valve, selector for remote start/stop, noise silencer

Incluso: quadro elettrico, valvola limitatrice di vuoto, settore locale/remoto, silenziatore

Standard version price / Prezzo versioni standard	Price / Prezzo / €	
CVAC 300	CVAC300-001	€ 22.911,00

Options available upon request / Opzioni su richiesta	Price / Prezzo / €	
CVAC 300 - In/Out Ø130 Safety cartridge HEPA H14 filter / Filtro di sicurezza HEPA H14 - 103.000cm ² 	H14	+ € 1.388,00
Additional silencer / Silenziatore supplementare	ADD/SIL	+ € 390,00
Inverter	INV	On Request

High Vacuum Central vacuum units with side channel blowers.

From 11 to 20 kW.

Side channel blower and protective carter.

A pressure relief valve is equipped as standard.

Electrical panel with direct starting, 24 Volt controls and L/R.

The price includes the electrical panel.

Centrali aspiranti con turbine a canale laterale.

Da 11 a 20 kW.

Pompa di Vuoto a Canale Laterale, Carter di protezione.

Dotati di Valvola limitatrice di vuoto di serie.

Pannello elettrico con avviamento diretto, comandi 24 Volt e L/R.

Il quadro elettrico è incluso nel prezzo.



TECHNICAL DATA / DATI TECNICI		CVAC 130HV	CVAC 180HV	CVAC 250HV
Voltage / Tensione	V - Hz	400 - 50 3~	400 - 50 3~	400 - 50 3~
Power / Potenza	kW	11	17,3	20
Waterlift max. / Depressione max.	mm.H ₂ O	5.100	6.000	5.000
Continuous Waterlift / Depressione in continuo	mm.H ₂ O	4.300	5.400	4.400
Air Flow max. / Portata d'aria max.	M ³ /h	520	720	1.100
Suction inlet / Bocchettone	mm	70	100	
Noise level / Rumorosità (EN ISO 3744)	dB(A)	74	77	78
Dimensions / Dimensioni	cm.	89x78x124h		103x93x197h

Included: electric panel board, pressure relief valve, selector for remote start/stop, noise silencer

Incluso: quadro elettrico, valvola limitatrice di vuoto, settore locale/remoto, silenziatore

Standard version price / Prezzo versioni standard	Price / Prezzo / €	
CVAC 130HV - NEW	CVAC130HV-001	€ 10.172,00
CVAC 180HV	CVAC180HV-001	€ 14.670,00
CVAC 250HV	CVAC250HV-001	€ 20.084,00

Options available upon request / Opzioni su richiesta	Price / Prezzo / €	
CVAC 130HV - CVAC 180HV - In/Out Ø100 Safety cartridge HEPA H14 filter / Filtro di sicurezza HEPA H14 - 52.000cm ²² 	H14	+ € 1.012,00
CVAC 250HV - In/Out Ø100 Safety cartridge HEPA H14 filter / Filtro di sicurezza HEPA H14 - 103.000cm ² 	H14	+ € 1.288,00
Additional silencer / Silenziatore supplementare	ADD/SIL	+ € 304,00
Inverter	INV	On Request

IL & CHIPS

INDUSTRIAL OIL AND CHIPS VACUUM CLEANERS *ASPIRATORI INDUSTRIALI PER OLIO E TRUCIOLI*

CHIPVAC



OILVAC



Tilting patented vacuum

With a large solid capacity designed to simplify the suction of a wide range of materials, also recovering any liquid.
Possibility of turning upside down - 50° or 90° - with the help of a forklift with a patented system simple and effective.
Simple material discharge and user-friendly maneuverability.
Sturdy construction 4mm thick suitable for intensive use.

Aspiratori a Benna, brevettati da DU-PUY

Con una grande capacità solidi e liquidi, progettati per semplificare l'aspirazione di grandi quantità di materiali di svariata natura.
Possibilità di capovolgersi su se stessa a 50° o 90° per mezzo di un carrello elevatore con un sistema brevettato semplice ed efficace.
Scarico del materiale aspirato semplificato con altissima manovrabilità della macchina e semplicità d'utilizzo.
Costruzione robusta di 4 mm di spessore per resistere nel tempo negli usi intensivi.

TECHNICAL DATA / DATI TECNICI		CHIPVAC 200	CHIPVAC 200HV	CHIPVAC 400M	CHIPVAC 400M HV
Voltage / Tensione	V - Hz	230 - 50 1~	230 - 50 1~	230 - 50 1~	230 - 50 1~
Power / Potenza	kW	3,3	2 x 1,6	3,3	2 x 1,6
Waterlift max. / Depressione max.	mm.H ₂ O	2.400	3.600	2.400	3.600
Air Flow max. / Portata d'aria max.	M ³ /h	540	340	540	340
Filter surface / Superficie filtrante	Cm ²	14.000			
Filter type / Tipo di filtro		Star / Tasche			
Ø filter / Ø filtro	mm.	420			
Media, class / Media, classe (IEC 60335-2-69) ²		Polyester - L			
Solids capacity / Capacità solidi	Lt.	200		400	
Ø Suction inlet / Ø Bocchettone	mm.	90		80	
Discharge system / Sistema di scarico	Patented	Patented Tilting 90° / Ribaltamento brevettato 90°		Guided Tilting 50° / Ribaltamento guidato 50°	
Noise level / Rumorosità (EN ISO 3744)	dB(A)	78	77	78	77
Dimensions / Dimensioni	cm.	109x94x135h	109x94x136h	133x75x165h	133x75x165h
Weight / Peso	kg.	155	157	280	280

Standard version price / Prezzo versioni standard	Price / Prezzo / €	
CHIPVAC 200	CHIPVAC200-001	€ 4.389,00
CHIPVAC 200HV	CHIPVAC200HV-001	€ 4.866,00
CHIPVAC 400M	CHIPVAC400MN-001	€ 7.128,00
CHIPVAC 400M HV	CHIPVAC400MN-002	€ 7.605,00

Optionals / Opzioni	Price / Prezzo / €	
CHIPVAC 200 - CHIPVAC 200HV Sieve grid for Oil & Chips / Griglia separazione Olio & Truciolo	SG	+ € 221,00
CHIPVAC 400M - CHIPVAC 400M HV Sieve grid for Oil & Chips / Griglia separazione Olio & Truciolo	SG	+ € 288,00
CHIPVAC 200 - CHIPVAC 200HV Class M Teflon filter Hydro-Oleophobic / Filtro Classe M Teflonato Idro-oleofobico	TF OWR	+ € 178,00
CHIPVAC 400M - CHIPVAC 400M HV Class M Teflon filter Hydro-Oleophobic / Filtro Classe M Teflonato Idro-oleofobico	TF OWR	+ € 178,00

Recommended accessory / Accessori consigliati	Price / Prezzo / €	
CHIPVAC 200 - Oil&Chips accessory kit Ø50 / Kit accessori Olio&Trucioli Ø50	TA.0620.0000	€ 272,00
CHIPVAC 400 - Oil&Chips accessory kit Ø50 / Kit accessori Olio&Trucioli Ø50	TA.1225.0000	€ 272,00
CHIPVAC 400 - Oil&Chips accessory kit Ø70 / Kit accessori Olio&Trucioli Ø70	TA.0622.0000	€ 435,00

TA.0620.0000



TA.1225.0000



TA.0622.0000



Tilting patented vacuum

With a large solid capacity designed to simplify the suction of a wide range of materials, also recovering any liquid.
Possibility of turning upside down - 50° - with the help of a forklift with a patented system simple and effective.
Simple material discharge and user-friendly maneuverability.
Sturdy construction 4mm thick suitable for intensive use.

Aspiratori a Benna, brevettati da DU-PUY

Con una grande capacità solidi e liquidi, progettati per semplificare l'aspirazione di grandi quantità di materiali di svariata natura.
Possibilità di capovolgersi su se stessa a 50° per mezzo di un carrello elevatore con un sistema brevettato semplice ed efficace.
Scarico del materiale aspirato semplificato con altissima manovrabilità della macchina e semplicità d'utilizzo.
Costruzione robusta di 4 mm di spessore per resistere nel tempo negli usi intensivi.

TECHNICAL DATA / DATI TECNICI		CHIPVAC 400	CHIPVAC 400HD
Voltage / Tensione	V - Hz	400 - 50 3~	400 - 50 3~
Power / Potenza	kW	7,5	12,5
Waterlift max. / Depressione max.	mm.H ₂ O	4.000	4.400
Continuous Waterlift / Depressione in continuo	mm.H ₂ O	2.700	2.900
Air Flow max. / Portata d'aria max.	M ³ /h	700	1.100
Filter surface / Superficie filtrante	Cm ²	30.000	30.000
Filter type / Tipo di filtro		Star / Tasche	
Ø filter / Ø filtro	mm.	560	
Media, class / Media, classe (IEC 60335-2-69) ²		Polyester - L	
Solids capacity / Capacità solidi	Lt.	400	
Ø Suction inlet / Ø Bocchettone	mm.	80	
Discharge system / Sistema di scarico	Patented	Guided Tilting 50° / Ribaltamento guidato 50°	
Noise level / Rumorosità (EN ISO 3744)	dB(A)	74	76
Dimensions / Dimensioni	cm.	147x105x207h	
Weight / Peso	kg.	490	555

Standard version price / Prezzo versioni standard	Price / Prezzo / €	
CHIPVAC 400	CHIPVAC400-001	€ 13.028,00
CHIPVAC 400HD	CHIPVAC400HD-001	€ 17.430,00

Optionals / Opzioni	Price / Prezzo / €	
Sieve grid for Oil & Chips / Griglia separazione Olio & Truciolo	SG	+ € 288,00
Class M Teflon filter Hydro-Oleophobic / Filtro Classe M Teflonato Idro-oleofobico	TF OWR	+ € 267,00

Recommended accessory / Accessori consigliati	Price / Prezzo / €	
Oil&Chips accessory kit Ø50 / Kit accessori Olio&Trucioli Ø50	TA.1225.0000	€ 272,00
Oil&Chips accessory kit Ø70 / Kit accessori Olio&Trucioli Ø70	TA.0622.0000	€ 435,00

TA.1225.0000



TA.0622.0000





TA.0966.0000 - Ø40 OILVAC 60
Included oil & chips Kit / Kit accessori incluso

Oil and chips recovery industrial vacuum for mechanic workshop

Powerful single-phase industrial vacuum cleaner. They meet the requirements of extraction and recovery of liquids, oils and emulsions, whether or not mixed with metal chips, dust or mud.

Big sieve basket grid for the metal chips separation and collection, and special filters for very fine dust.

Liquids capacity up to 100 Lt with easy independent discharge pump. Integrated floating device.

Aspiratore olio/truciolo monofase per l'industria Meccanica.

Potenti aspiratori monofase, nascono per rispondere alle esigenze di recupero di liquidi, oli, emulsioni misti a trucioli, polveri e fanghi.

Dotati di cestello grigliato in acciaio per la raccolta dei trucioli e filtri per la microfiltrazione dell'olio da polveri metalliche.

Contenitore raccolta liquido da 60 a 100lt con pompa indipendente di scarico disponibile. Galleggiante integrato per arresto aspirazione a livello massimo raggiunto.

TECHNICAL DATA / DATI TECNICI		OILVAC 60	OILVAC 100	OILVAC 100 P
Voltage / Tensione	V - Hz	230 - 50 1~	230 - 50 1~	
Power / Potenza	kW	1,1	2 x 1,1	
Waterlift max. / Depressione max.	mm.H ₂ O	2.400	2.400	
Air Flow max. / Portata d'aria max.	M ³ /h	180	360	
Filter surface / Superficie filtrante	Cm ²	2.000	1.200	
Filter type / Tipo di filtro		Bag / Sacco		
Ø filter / Ø filtro	mm.	240	260	
Media, class / Media, classe (IEC 60335-2-69) ²		Polypropilene 100 Micron		
Liquids capacity / Capacità liquidi	Lt.	65	90	
Solids capacity / Capacità solidi	Lt.	10	30	
Solids capacity for very fine dust metal dust Capacità solidi cestello limaia metallica	Lt.	N.A.	Optional	10
Oil filter grade / Grado filtrazione olio	µ	N.A.	Optional	PPL 300
Ø Suction inlet / Ø Bocchettone	mm.	40	50	
Floating device / Galleggiante		Yes / Sì	Yes Electric / Sì Elettrico	
Discharge system / Sistema di scarico		Ball valve Valvola sfera manuale		Electric pump 100lt/min
Noise level / Rumorosità (EN ISO 3744)	dB(A)	80	77	77
Dimensions / Dimensioni	cm.	64x56x99h	73x58x124h	
Weight / Peso	kg.	25	60	65

Standard version price / Prezzo versioni standard	Price / Prezzo / €	
OILVAC 60	OILVAC60-001	€ 1.337,00
OILVAC 100	OILVAC100-001	€ 2.255,00
OILVAC 100 PUMP	OILVAC100PUMP-001	€ 3.135,00

Optionals / Opzioni	Price / Prezzo / €	
OILVAC 100 P - PPL 100 Micron filter - Filtro PPL 100 Micron	FI.0450.0000	+ € 65,00

Recommended accessory / Accessori consigliati	Price / Prezzo / €	
OILVAC 100/100 P - Recommended accessory Ø50 / Kit accessori consigliato Ø50	TA.0621.0000	€ 318,00



Oil and chips recovery industrial vacuum for mechanic workshop

Powerful and spacious industrial vacuum cleaner for mechanical use. Suitable for the extraction and recovery of liquids, oils and emulsions, whether or not mixed with metal chips, dust or mud. Big sieve basket grid for the metal chips separation and collection, and special filters for very fine dust. Liquids capacity up to 130 lt with easy independent discharge pump. Integrated floating device.

Aspiratore olio/truciolo monofase per l'industria Meccanica.

Potente e capiente aspiratore per settore della meccanica, adatto a soddisfare le esigenze di recupero liquidi, oli, emulsioni misti a trucioli, polveri e fanghi.

Dotato di cestello grigliato in acciaio per la raccolta dei trucioli e filtro per la microfiltrazione dell'olio da polveri metalliche.

Contenitore raccolta liquido fino a 130lt con pompa indipendente di scarico disponibile. Galleggiante integrato per arresto aspirazione a livello massimo raggiunto.

TECHNICAL DATA / DATI TECNICI		OILVAC 130	OILVAC 130P
Voltage / Tensione	V - Hz	230 - 50 1~	230 - 50 1~
Power / Potenza	kW	3 x 1,1*	3 x 1,1*
Waterlift max. / Depressione max.	mm.H ₂ O	2.400	2.400
Air Flow max. / Portata d'aria max.	M ³ /h	540	540
Filter surface / Superficie filtrante	Cm ²	14.000	14.000
Filter type / Tipo di filtro		Star / Tasche	Star / Tasche
Ø filter / Ø filtro	mm.	420	420
Media, class / Media, classe (IEC 60335-2-69) ²		M Hydro-Oleophobe	M Hydro-Oleophobe
Liquids capacity / Capacità liquidi	Lt.	130	130
Solids capacity / Capacità solidi	Lt.	30	30
Solids capacity for very fine dust metal dust Capacità solidi cestello limaia metallica	Lt.	Optional	10
Oil filter grade / Grado filtrazione olio	µ	Optional	PPL 300
Ø Suction inlet / Ø Bocchettone	mm.	50	50
Floating device / Galleggiante		Yes Electric / Si Elettrico	
Discharge system / Sistema di scarico		Ball valve / Valvola sfera manuale	Electric pump 100lt/min Pompa elettrica 100lt/min
Noise level / Rumorosità (EN ISO 3744)	dB(A)	78	78
Dimensions / Dimensioni	cm.	70x62x144h	70x62x144h
Weight / Peso	kg.	83	90

* HV Version available, with 3 motors with three stages 3 x 1,3 kW / Disponibile in versione HV, con 3 motori a tre stadi 3 x 1,3 kW

Standard version price / Prezzo versioni standard	Price / Prezzo / €	
OILVAC 130	OILVAC130-001	€ 3.015,00
OILVAC 130 PUMP	OILVAC130PUMP-001	€ 4.059,00

Optionals / Opzioni	Price / Prezzo / €	
OILVAC 130P - PPL 100 Micron filter - Filtro PPL 100 Micron	FI.0450.0000	+ € 65,00

Recommended accessory / Accessori consigliati	Price / Prezzo / €	
Recommended accessory Ø50 / Kit accessori consigliato Ø50	TA.0837.0000	€ 288,00



Oil and chips recovery industrial vacuum for mechanic workshop

Powerful, compact and mobile vacuum cleaners for mechanical use. Suitable for the extraction and recovery of liquids, oils and emulsions, whether or not mixed with metal chips, dust or mud. Big sieve basket grid for the metal chips separation and collection, and special filters for very fine dust. Liquids capacity up to 200 lt with easy independent discharge pump. Integrated floating device.

Aspiratore olio/truciolo monofase per l'industria Meccanica.

Potenti, compatti ed ergonomici aspiratori per settore meccanica, adatti a soddisfare le esigenze di recupero liquidi, oli, emulsioni misti a trucioli, polveri e fanghi.

Dotati di cestello grigliato in acciaio per la raccolta dei trucioli e filtro per la microfiltrazione dell'olio da polveri metalliche.

Contenitore raccolta liquido fino a 200lt con pompa indipendente di scarico disponibile. Galleggiante integrato per arresto aspirazione a livello massimo raggiunto.

TECHNICAL DATA / DATI TECNICI		OILVAC 200	OILVAC 200T
Voltage / Tensione	V - Hz	230 - 50 1~	400 - 50 3~
Power / Potenza	kW	2 x 1,6*	3
Waterlift max. / Depressione max.	mm.H ₂ O	2.400	3.200
Air Flow max. / Portata d'aria max.	M ³ /h	540	350
Filter surface / Superficie filtrante	Cm ²	14.000	14.000
Filter type / Tipo di filtro		Star / Tasche	
Ø filter / Ø filtro	mm.	420	420
Media, class / Media, classe (IEC 60335-2-69) ²		M Hydro-Oleophobe	
Liquids capacity / Capacità liquidi	Lt.	200	200
Solids capacity / Capacità solidi	Lt.	30	30
Solids capacity for very fine dust metal dust Capacità solidi cestello limaia metallica	Lt.	10	10
Oil filter grade / Grado filtrazione olio	µ	PPL 300	PPL 300
Ø Suction inlet / Ø Bocchettone	mm.	50	50
Floating device / Galleggiante		Yes / Si	Yes / Si
Discharge system / Sistema di scarico		Electric pump 180 lt/min - Pompa elettrica 180 lt/min	
Noise level / Rumorosità (EN ISO 3744)	dB(A)	78	76
Dimensions / Dimensioni	cm.	122x62x130h	122x62x155h
Weight / Peso	kg.	205	224

* HV Version available, with 3 motors with three stages 3 x 1,3 kW for application with high water lift value needed.

Disponibile in versione HV, con 3 motori a tre stadi 3 x 1,3 kW per applicazioni con elevate esigenze di depressione

Standard version price / Prezzo versioni standard	Price / Prezzo / €	
OILVAC 200	OILVAC200-001	€ 6.105,00
OILVAC 200 T	OILVAC200T-001	€ 6.875,00
Optionals / Opzioni	Price / Prezzo / €	
PPL 100 Micron filter - Filtro PPL 100 Micron	FI.0404.0000	+ € 89,00
Recommended accessory / Accessori consigliati	Price / Prezzo / €	
Kit accessori consigliato Ø50 / Recommended accessory Ø50	TA.0621.0000	€ 318,00



Oil and chips recovery industrial vacuum with independent discharge pump

Great performances even in continuous 24/7 duty applications.

Massive volume recovery capacity.

Big sieve basket grid for the metal chips separation and collection with easy discharge system.

Liquids capacity up to 300lt with easy independent discharge pump

Integrated floating device.

Able to recover big quantities of dense oil, swarf and sludge.

Aspiratore olio/truciolo trifase con pompa di scarico

Potenti turbine a canale laterale adatte al servizio continuativo 24h/7g e idonee all'aspirazione e filtrazione di grandi quantità di liquidi, trucioli e fanghi.

Cestello grigliato in acciaio per la raccolta dei trucioli con sistema di svuotamento facilitato con ribaltamento.

Contenitore raccolta liquido fino a 300lt con pompa indipendente scarico.

Galleggiante integrato.

Idoneo per aspirare oli densi, morchia, sedimenti.

TECHNICAL DATA / DATI TECNICI		OILVAC 300
Voltage / Tensione	V - Hz	400 - 50 3~
Power / Potenza	kW	4
Waterlift max. / Depressione max.	mm.H ₂ O	3.600
Air Flow max. / Portata d'aria max.	M ³ /h	320
Filter surface / Superficie filtrante	Cm ²	14.000
Filter type / Tipo di filtro		Star / Tasche
Ø filter / Ø filtro	mm.	420
Media, class / Media, classe (IEC 60335-2-69) ²		M Hydro-Oleophobe
Liquids capacity / Capacità liquidi	Lt.	300
Solids capacity / Capacità solidi	Lt.	65
Solids capacity for very fine dust metal dust Capacità solidi cestello limaia metallica	Lt.	N.A
Oil filter grade / Grado filtrazione olio	µ	PPL 300
Ø Suction inlet / Ø Bocchettone	mm.	50
Floating device / Galleggiante		Yes Electric / Sì Elettrico
Discharge system / Sistema di scarico		Electric pump 180lt/min / Pompa elettrica 180lt/min
Noise level / Rumorosità (EN ISO 3744)	dB(A)	77
Dimensions / Dimensioni	cm.	145x72x188h
Weight / Peso	kg.	275

Standard version price / Prezzo versioni standard		Price / Prezzo / €	
OILVAC 300		OILVAC300-001	€ 9.458,00
Optionals / Opzioni		Price / Prezzo / €	
OILVAC 300 - Micron filter - Filtro PPL 100 Micron		FI.0278.0000	+ € 27,00
Recommended accessory / Accessori consigliati		Price / Prezzo / €	
Kit accessori consigliato Ø50 / Recommended accessory Ø50		TA.0887.0000	€ 403,00



Oil and chips recovery industrial vacuum with independent discharge pump

Great performances even in continuous 24/7 duty applications.

Massive volume recovery capacity.

Big sieve basket grid for the metal chips separation and collection with easy discharge system.

Liquids capacity up to 450lt with easy independent discharge pump Integrated floating device.

Able to recover big quantities of dense oil, swarf and sludge.

Aspiratore olio/truciolo trifase con pompa di scarico

Potenti turbine a canale laterale adatte al servizio continuativo 24h/7g e idonee all'aspirazione e filtrazione di grandi quantità di liquidi, trucioli e fanghi.

Cestello grigliato in acciaio per la raccolta dei trucioli con sistema di svuotamento facilitato con ribaltamento.

Contenitore raccolta liquido fino a 450lt con pompa indipendente scarico. Galleggiante integrato.

Idoneo per aspirare oli densi, morchia, sedimenti.

TECHNICAL DATA / DATI TECNICI		OILVAC 450HV	OILVAC 600HV
Voltage / Tensione	V - Hz	400 - 50 3~	400 - 50 3~
Power / Potenza	kW	5,5	11
Waterlift max. / Depressione max.	mm.H ₂ O	5.100	4.700
Continuous Waterlift / Depressione in continuo	mm.H ₂ O	4.400*	4.300**
Air Flow max. / Portata d'aria max.	M ³ /h	320	520
Filter surface / Superficie filtrante	Cm ²	14.000	14.000
Filter type / Tipo di filtro		Star / Tasche	
Ø filter / Ø filtro	mm.	420	
Media, class / Media, classe (IEC 60335-2-69) ²		M Hydro-Oleophobe	
Liquids capacity / Capacità liquidi	Lt.	450	600
Solids capacity / Capacità solidi	Lt.	65	
Solids capacity for very fine dust metal dust Capacità solidi cestello limaia metallica	Lt.	15	
Oil filter grade / Grado filtrazione olio	µ	PPL 300	
Ø Suction inlet / Ø Bocchettone	mm.	50	50
Floating device / Galleggiante		Yes Electric / Si Elettrico	
Discharge system / Sistema di scarico		Electric pump 300l/min / Pompa elettrica 300lt/min	
Noise level / Rumorosità (EN ISO 3744)	dB(A)	78	
Dimensions / Dimensioni	cm.	158x72x203h	180x85x205h
Weight / Peso	kg.	295	415

* Value with non returne valve (not included) / Valore in presenza di valvola anti-riflusso (non inclusa di serie)

** Value with non returne valve (included as standard) / Valore in presenza di valvola anti-riflusso (inclusa di serie)

Standard version price / Prezzo versioni standard	Price / Prezzo / €	
OILVAC 450 HV	OILVAC450HV-001	€ 12.265,00
OILVAC 600 HV	OILVAC600HV-001	€ 18.192,00

Optionals / Opzioni		Price / Prezzo / €	
Micron filter - <i>Filtro PPL 100 Micron</i>	FI.0451.0000	+ € 27,00	
Recommended accessory / Accessori consigliati		Price / Prezzo / €	
Kit accessori consigliato Ø50 / <i>Recommended accessory Ø50</i>	TA.0887.0000	€ 403,00	



SUMP cleaner for sludge and muds.

Designed for a complete cleaning of CNC machines.

- Vacuums up to 500 lt. of coolant, oils and emulsions mixed with chips, dusts and sludge.
- Solids and chips are separated into an integrated container, the liquids are purified by a filtering TNT sheet.
- Possibility of cleaning the emptied tank through adjustable high pressure lance.
- Independent pump 200lt/min for the recovery of the lubricants.

Aspiratore per rimozione di fanghi e morchie.

Progettato per una pulizia completa delle macchine CNC.

- Aspira fino a 500 lt. di refrigerante ed oli misti a trucioli, polveri e fanghi.
- Solidi e trucioli vengono separati in un contenitore integrato, i liquidi vengono depurati per mezzo di un telo filtrante in TNT.
- Possibilità di pulizia della vasca svuotata tramite lancia ad alta pressione regolabile.
- Pompa indipendente 200lt/min per il re-inserimento dell'emulsionante in vasca.

TECHNICAL DATA / DATI TECNICI		OILVAC 500
Voltage / Tensione	V - Hz	400 - 50 3~
Power / Potenza	kW	4
Waterlift max. / Depressione max.	mm.H ₂ O	3.200
Continuous Waterlift / Depressione in continuo	mm.H ₂ O	2.400
Air Flow max. / Portata d'aria max.	M ³ /h	420
Filter surface / Superficie filtrante		Filtering sheet in TNT / Telo filtrante in TNT
Filter grade / Grado filtrazione	μ	50
Liquids capacity / Capacità liquidi	Lt.	500
Solids capacity / Capacità solidi	Lt.	75
Floating device / Galleggiante		Yes Electric / Sì Elettrico
Liquids discharge system / Sistema di scarico liquidi		Electric pump 200lt/min - Pompa elettrica 200lt/min
Solids discharge system / Sistema di scarico solidi		Dump tank with a forklift / Cassonetto ribaltabile con muletto
Washing system / Sistema di lavaggio macchina		Adjustable High-Pressure lance 0-70 bar Lancia ad alta pressione regolabile 0-70 bar
Noise level / Rumorosità (EN ISO 3744)	dB(A)	75
Dimensions / Dimensioni	cm.	182x101x134h
Weight / Peso	kg.	520

Standard version price / Prezzo versioni standard	Price / Prezzo / €	
OILVAC 500	OILVAC500-001	€ 28.589,00

Recommended accessory / Accessori consigliati	Price / Prezzo / €	
Kit accessori consigliato Ø50 / Recommended accessory Ø50	TA.0887.0000	€ 403,00



APPLICATION DETAILS

DETTAGLI APPLICAZIONE

APPLICATION DETAILS	YES	NO	DESCRIPTIONS
O.E.M.			
End User			
Machine tool type			
Working process			
Material machined			
Emulsion or Neat Oil			
Chips present			
Dimension/Volume of Cabin m ³			
Closed cabin			
Open cabin (no door)			
Throughput m ³ /h			
Working temperature			
Pre-filter			
Absolute post-filter			
Daily working hours			
Installation on top of machine			
Installation beside the machine (on a stand)			
Installation with wall mounting			
Installation by the customer			
Suction connections Ø			
Electrical connections			
Interface with the machine tool			
Voltage and frequency			
Comments:			

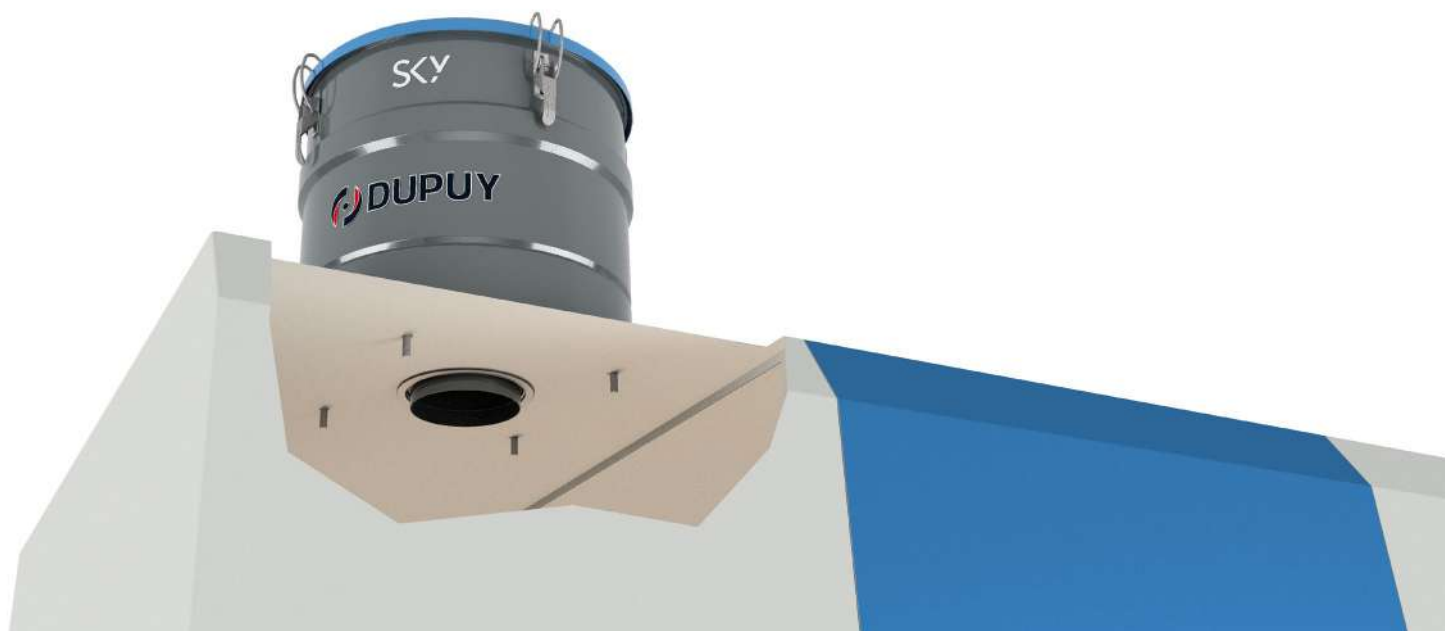

SKY

OIL MIST FILTER *FILTRI PER NEBBIE OLEOSE*

SKY





SKY is a range of stand-alone oil mist filter for mist generated from neat oil and emulsions used in machine tools in mechanical industry.

With high airflows from 250 to 2500 m³/h, they are able to filter the pollutants produced by machine tools.

SKY è una gamma di aspiratori per nebbie oleose generate dalle macchine dell'industria Meccanica.

Con portate da 250 a 2500 m³/h, sono in grado di filtrare gli inquinanti prodotti dalle macchine utensili e rimettere in ambiente aria depurata recuperando l'olio o emulsioni.

TECHNICAL DATA / DATI TECNICI		SKY 250	SKY 500	SKY 1000	SKY 1500	SKY 2000	SKY 2500
Voltage / Tensione	V - Hz	400 - 50 3~		400 - 50 3~		400 - 50 3~	
Power / Potenza	kW	0,12	0,18	0,37	0,55	0,75	1,1
Air Flow max. / Portata d'aria max.	M ³ /h	250	500	1.000	1.500	2.000	2.500
Filter type / Tipo di filtro		Multilayer or Cartridge (Cart series)					
Ø filter / Ø filtro	mm.	Ø280 / Ø290		Ø310 / Ø350		Ø370 / Ø410	
Media, class / Media, classe (IEC 60335-2-69) ²		G3-G4 or M (Cart series)					
Filter surface / Superficie filtrante	Cm ²	2.300/20.000		3.000/60.000		4.100/100.000	
Ø Suction inlet / Ø Bocchettone	mm.	100		150		200	
Noise level / Rumorosità (EN ISO 3744)	dB(A)	62		64		65	
Dimensions / Dimensioni	cm.	Ø39x47h		Ø49x54h		Ø59x59h	
Weight / Peso	kg.	17	18	30	33	46	50

Price / Prezzo		Price / Prezzo / €		
Version with: / Versione con:		Multilayer filter		Cartridge filter
SKY 250	SKY250-001	€ 1.309,00	SKY250C-001	€ 1.447,00
SKY 500	SKY500-001	€ 1.447,00	SKY500C-001	€ 1.583,00
SKY 1000	SKY1000-001	€ 1.999,00	SKY1000C-001	€ 2.165,00
SKY 1500	SKY1500-001	€ 2.201,00	SKY1500C-001	€ 2.367,00
SKY 2000	SKY2000-001	€ 2.547,00	SKY2000C-001	€ 2.819,00
SKY 2500	SKY2500-001	€ 2.814,00	SKY2500C-001	€ 3.093,00

Installation kit included: 2mt oil discharge hose, clamp Ø20, rubber joint.

Incluso nel prezzo kit installazione: 2mt tubo scarico olio, fascetta Ø20, guarnizione.

Optionals / Opzioni		Price / Prezzo / €	
(SKY250 - SKY500) Installation Kit with riser / Kit installazione con rialzo		TA.0880.0000	+ € 180,00
(SKY1000 - SKY1500) Installation Kit with riser / Kit installazione con rialzo		TA.0881.0000	+ € 221,00
(SKY2000 - SKY2500) Installation Kit with riser / Kit installazione con rialzo		TA.0882.0000	+ € 260,00
(SKY250 - SKY500) Installation Kit with adjustable riser / Kit installazione con rialzo regolabile		TA.0888.0000	+ € 234,00
(SKY1000 - SKY1500) Installation Kit with adjustable riser / Kit installazione con rialzo regolabile		TA.0889.0000	+ € 313,00
(SKY2000 - SKY2500) Installation Kit with adjustable riser / Kit installazione con rialzo regolabile		TA.0890.0000	+ € 375,00
(SKY250 - SKY500) Wall mounting Kit / Kit montaggio a muro		TA.0891.0000	+ € 199,00
(SKY1000 - SKY1500) Wall mounting Kit / Kit montaggio a muro		TA.0892.0000	+ € 259,00
(SKY2000 - SKY2500) Wall mounting Kit / Kit montaggio a muro		TA.0893.0000	+ € 321,00

Optionals / Opzioni	Price / Prezzo / €		
(SKY250-SKY500) Adjustable column for floor fixing from 1,5 to 2,5 mt <i>Piantana a colonna regolabile da 1,5 a 2,5 mt per fissaggio a pavimento</i>		TA.0894.0000	+ € 438,00
(SKY1000-SKY1500) Adjustable column for floor fixing from 1,5 to 2,5 mt <i>Piantana a colonna regolabile da 1,5 a 2,5 mt per fissaggio a pavimento</i>		TA.0895.0000	+ € 537,00
(SKY2000-SKY2500) Adjustable column for floor fixing from 1,5 to 2,5 mt <i>Piantana a colonna regolabile da 1,5 a 2,5 mt per fissaggio a pavimento</i>		TA.0896.0000	+ € 631,00
(SKY250-SKY500) KIT HEPA H13 Final Filter efficiency 99,99% surface 30.000 cm ² <i>Kit Post Filtro HEPA H13 efficienza 99,99% superficie 30.000 cm²</i>		KT.1574.3020	+ € 320,00
(SKY1000-SKY1500) KIT HEPA H13 Final Filter efficiency 99,99% surface 90.000 cm ² <i>Kit Post Filtro HEPA H13 efficienza 99,99% superficie 90.000 cm²</i>		KT.1575.3020	+ € 480,00
(SKY2000-SKY2500) KIT HEPA H13 Final Filter efficiency 99,99% surface 150.000 cm ² <i>Kit Post Filtro HEPA H13 efficienza 99,99% superficie 150.000 cm²</i>		KT.1576.3020	+ € 680,00
(SKY250-SKY500) Kit Cyclon Pre-Filter / <i>Kit Pre-filtro ciclonico</i>		TA.0897.0000	+ € 760,00
(SKY1000-SKY1500) Kit Cyclon Pre-Filter / <i>Kit Pre-filtro ciclonico</i>		TA.0898.0000	+ € 921,00
(SKY2000-SKY2500) Kit Cyclon Pre-Filter / <i>Kit Pre-filtro ciclonico</i>		TA.0899.0000	+ € 1004,00
Pressure Gauge for filter clogging <i>Manometro rilevazione intasamento filtro</i>		TA.0900.0000	+ € 354,00
ABB rotary Switch with thermal motor protection <i>Interruttore rotativo ABB con magnetotermico</i>		-	+ € 254,00

Spare parts / Ricambi	Price / Prezzo / €		
(SKY250-SKY500) Filtro multilayer G2-G3 / <i>Multilayer Filter G2-G3</i>		FI.0422.0000	€ 43,00
(SKY1000-SKY1500) Filtro multilayer G2-G3 / <i>Multilayer Filter G2-G3</i>		FI.0423.0000	€ 53,00
(SKY2000-SKY2500) Filtro multilayer G2-G3 / <i>Multilayer Filter G2-G3</i>		FI.0424.0000	€ 76,00
(SKY250-SKY500) Filtro cartuccia Cat.M / <i>Cartridge Filter Cat. M</i>		FI.0645.0000	€ 200,00
(SKY1000-SKY1500) Filtro cartuccia Cat.M / <i>Cartridge Filter Cat. M</i>		FI.0646.0000	€ 253,00
(SKY2000-SKY2500) Filtro cartuccia Cat.M / <i>Cartridge Filter Cat. M</i>		FI.0647.0000	€ 360,00
(SKY250-SKY500) Filtro coalescente con velcro / <i>Coalescent filter with velcro</i>		FI.0425.0000	€ 26,50
(SKY1000-SKY1500) Filtro coalescente con velcro / <i>Coalescent filter with velcro</i>		FI.0426.0000	€ 33
(SKY2000-SKY2500) Filtro coalescente con velcro / <i>Coalescent filter with velcro</i>		FI.0427.0000	€ 39,60
Tubo scarico olio Ø20 mm / <i>Flexible hose Ø20 mm oil discharge</i>		TA.0903.0000	€ 12,00 / mt
(SKY250-SKY500) Tubo poliuretano Ø100 mm / <i>Flexible hose Ø100 mm</i>		TA.0901.0000	€ 39,00 / mt
(SKY1000-SKY1500) Tubo poliuretano Ø150 mm / <i>Flexible hose Ø150 mm</i>		TA.0479.0000	€ 52,00 / mt
(SKY2000-SKY2500) Tubo poliuretano Ø200 mm / <i>Flexible hose Ø200 mm</i>		TA.0902.0000	€ 65,00 / mt
(SKY250-SKY500) Fascetta stringitubo / <i>Hose clamp Ø100 mm</i>		SL.1211.0000	€ 11,00
(SKY250-SKY500) Fascetta stringitubo / <i>Hose clamp Ø150 mm</i>		SL.4651.0000	€ 14,00
(SKY250-SKY500) Fascetta stringitubo / <i>Hose clamp Ø200 mm</i>		SL.2148.0000	€ 18,00

 **DUPUY**



DEDUST

INDUSTRIAL DUST COLLECTORS *DEPOLVERATORI INDUSTRIALI*

DEDUST PRO



DEDUST





Applications: Dry / for light and fine suspended particles of dust
Installation: compact and mobile
Material: complete painted steel structure
Filter: polyester L class with manual filter cleaning system
Speciality: high airflow dust collector

Applicazione: polveri / per polveri fini in sospensione nell'aria
Ingombro: compatto e facile da trasportare
Materiale: costruzione completa in acciaio verniciato
Filtro: poliestere classe L con sistema di pulizia del filtro manuale
Specialità: depolveratore ad alta portata d'aria

TECHNICAL DATA / DATI TECNICI		DEDUST 10 PRO
Voltage / Tensione	V - Hz	400 - 50 3~
Power / Potenza	kW	0,75
Water Lift max. / Depressione max.	mm.H ₂ O	180
Air Flow max. / Portata d'aria max.	M ³ /h	1.000
Filter surface / Superficie filtrante	Cm ²	20.000
Filter type / Tipo di filtro		Star / Tasche
Ø filter / Ø filtro	mm.	420
Media, class / Media, classe (IEC 60335-2-69) ²		Polyester L
Filter cleaning system / Sistema di pulizia filtri ***		Manual / Manuale
Solids capacity / Capacità solidi	Lt.	40
Ø Suction inlet / Ø Bocchettone	mm.	100
Noise level / Rumorosità (EN ISO 3744)	dB(A)	70
Dimensions / Dimensioni	cm.	71x57x153h
Weight / Peso	kg.	60

Standard version price / Prezzo versioni standard	Price / Prezzo / €	
DEDUST 10 PRO	DEDUST10PRO-001	€ 3.105,00

Optionals / Opzioni	Price / Prezzo / €	
H14 HEPA Absolute Filter / Filtro assoluto Hepa H11	H14	+ € 550,00
Antistatic Class M filter / Filtro Classe M Antistatico	M ANT	+ € 112,00
Stainless steel collection tank AISI 304 / Contenitore in acciaio inox AISI 304	X	+ € 254,00
Stainless steel AISI 304 tank and filter chamber / Contenitore e camera in acciaio inox AISI 304	XX	+ € 654,00
Earth grounding / Messa a terra	EG	+ € 100,00
Single phase motor / Motore monofase	SP	+ € 150,00
Activated carbon filter / Filtro a carboni attivi	CA	+ € 485,00
Ø100 L=3000mm - Extraction arm / Braccio articolato	TA.0943.0000	+ € 1.290,00
Connection for flex hose / Raccordo per tubo flex Ø100/100	SL.4712.0200	Included
Connection for flex hose / Raccordo per tubo flex Ø100/80	SL.4713.0200	+ € 95,00



Applications: Dry / for light and fine suspended particles of dust
Installation: compact and mobile
Material: complete painted steel structure
Filter: polyester L class with manual filter cleaning system
Speciality: high airflow dust collector

Applicazione: polveri / per polveri fini in sospensione nell'aria
Ingombro: compatto e facile da trasportare
Materiale: costruzione completa in acciaio verniciato
Filtro: poliestere classe L con sistema di pulizia del filtro manuale
Specialità: depolveratore ad alta portata d'aria

TECHNICAL DATA / DATI TECNICI		DEDUST 30 PRO	DEDUST 50 PRO
Voltage / Tensione	V - Hz	400 - 50 3~	400 - 50 3~
Power / Potenza	kW	2,2	4
Water Lift max. / Depressione max.	mm.H ₂ O	210	370
Air Flow max. / Portata d'aria max.	M ³ /h	2.500	3.500
Filter surface / Superficie filtrante	Cm ²	50.000	
Filter type / Tipo di filtro		Star / Tasche	
Ø filter / Ø filtro	mm.	560	
Media, class / Media, classe (IEC 60335-2-69) ²		Polyester ANT M	
Filter cleaning system / Sistema di pulizia filtri ***		Manual / Manuale	
Solids capacity / Capacità solidi	Lt.	100	
Ø Suction inlet / Ø Bocchettone	mm.	200	
Noise level / Rumorosità (EN ISO 3744)	dB(A)	72	74
Dimensions / Dimensioni	cm.	78x85x205h	78x85x214h
Weight / Peso	kg.	110	130

Standard version price / Prezzo versioni standard	Price / Prezzo / €	
DEDUST 30 PRO	DEDUST30PRO-001	€ 5.185,00
DEDUST 50 PRO	DEDUST50PRO-001	€ 6.075,00

Optionals / Opzioni	Price / Prezzo / €	
H14 HEPA Absolute Filter / Filtro assoluto Hepa H11	H14	+ € 1.110,00
Stainless steel collection tank AISI 304 / Contenitore in acciaio inox AISI 304	X	+ € 785,00
Stainless steel AISI 304 tank and filter chamber / Contenitore e camera in acciaio inox AISI 304	XX	+ € 2.245,00
Earth grounding / Messa a terra	EG	+ € 140,00
DEDUST30 PRO - Ø150 L=3000mm - Extraction arm / Braccio articolato	TA.0177.0000	+ € 1.265,00
DEDUST50 PRO - Ø200 L=3000mm - Extraction arm / Braccio articolato	TA.0511.0000	+ € 1.610,00
Connection for flex hose / Raccordo per tubo flex Ø150/150	SL.2607.0200	+ € 110,00
Connection for flex hose / Raccordo per tubo flex Ø150/120	SL.2639.0200	+ € 110,00
Connection for flex hose / Raccordo per tubo flex Ø150/100	SL.2635.0200	+ € 110,00
Connection for flex hose / Raccordo per tubo flex Ø200/200	SL.2632.0200	+ € 125,00



Applications: Dry / for light and fine suspended particles of dust
Installation: mobile
Material: complete painted steel structure
Filter: antistatic polyester class M with pressure gauge for filter clogging detection
Speciality: high airflow dust collector with suction arm

Applicazione: polveri / per polveri fini in sospensione nell'aria
Ingombro: facile da trasportare
Materiale: costruzione completa in acciaio verniciato
Filtro: poliestere antistatico classe M con manometro rilevazione intasamento filtro
Specialità: depolveratore ad alta portata d'aria con braccio regolabile

TECHNICAL DATA / DATI TECNICI		DEDUST 1
Voltage / Tensione	V - Hz	400 - 50 3~
Power / Potenza	kW	1,1
Water Lift min-max / Depressione min-max	mm.H ₂ O	121-144
Air Flow max-min / Portata d'aria max-min	M ³ /h	2100 - 1350
Filter surface / Superficie filtrante	Cm ²	100.000
Filter type / Tipo di filtro		Cartridge / Cartuccia
Ø filter / Ø filtro	mm.	325
Media, class / Media, classe (IEC 60335-2-69) ²		Polyester ANT M *
Filter cleaning system / Sistema di pulizia filtri ***		Automatic PN only PN version / Automatico PN solo versione PN
Solids capacity / Capacità solidi	Lt.	5
Ø Suction inlet / Ø Bocchettone	mm.	150**
Noise level / Rumorosità (EN ISO 3744)	dB(A)	69
Dimensions / Dimensioni	cm.	88x83x106h
Weight / Peso	kg.	145

* Other filter media available upon request / Altri media filtranti disponibili a richiesta

** Suction inlet not included; different diameters available / Bocchettone aspirazione non incluso; vari diametri disponibili

*** On PN version air compressor not included / Nella versione PN il compressore d'aria non è incluso

Standard version price / Prezzo versioni standard	Price / Prezzo / €	
DEDUST 1	DEDUST1-001	€ 4.315,00
DEDUST 1 PN****	DEDUST1PN-001	€ 5.745,00

**** With reverse flow automatic pneumatic filter cleaning system / Con sistema di pulizia automatico pneumatico in controcorrente d'aria

Optionals / Opzioni	Price / Prezzo / €	
PTFE Antistatic coated Class M filter / Filtro Classe M PTFE Antistatico	FI.0487.0000	+ € 87,00
H13 HEPA Absolute Filter 99,95% / Filtro assoluto Hepa H13 efficienza	TA.1201.0000	+ € 469,00
Spark trap kit / Kit spegniscintilla	-	Upon Request
Activated carbon filter / Filtro a carboni attivi (20kg)	TA.1202.0000	+ € 833,00
ULTRAFLEX Ø150 L=3000mm - Self supporting extraction arm / Braccio autoportante	TA.0944.0000	+ € 1.120,00
TECHFLEX Ø150 L=3000mm - Extraction arm / Braccio articolato	TA.0177.0000	+ € 1.473,00

TA.0944.0000



TA.0177.0000





Applications: Dry / for light and fine suspended particles of dust
Installation: mobile
Material: complete painted steel structure
Filter: polyester class M Antistatic with automatic filter cleaning system
Speciality: high airflow dust collector with suction arm

Applicazione: polveri / per polveri fini in sospensione nell'aria
Ingombro: facile da trasportare
Materiale: costruzione completa in acciaio verniciato
Filtro: poliestere classe M Antistatico con sistema di pulizia automatico dei filtri
Specialità: depolveratore ad alta portata d'aria con braccio regolabile

TECHNICAL DATA / DATI TECNICI		DEDUST 2
Voltage / Tensione	V - Hz	400 - 50 3~
Power / Potenza	kW	1,5
Water Lift min-max / Depressione min-max	mm.H ₂ O	115 - 142
Air Flow max-min. / Portata d'aria max-min.	M ³ /h	2400 - 1350
Filter surface / Superficie filtrante	Cm ²	2 x 100.000 - 200.000
Filter type / Tipo di filtro		2 x Cartridge / Cartuccia
Ø filter / Ø filtro	mm.	325
Media, class / Media, classe (IEC 60335-2-69) ²		Polyester ANT M
Filter cleaning system / Sistema di pulizia filtri **		Automatic PN / Automatico PN
Solids capacity / Capacità solidi	Lt.	30
Ø Suction inlet / Ø Bocchettone	mm.	2 x 150* 1 x 200
Noise level / Rumorosità (EN ISO 3744)	dB(A)	70
Dimensions / Dimensioni	cm.	120x83x172h
Weight / Peso	kg.	235

* Suction inlet not included; different diameters available / Bocchettone aspirazione non incluso; vari diametri disponibili

** Air compressor not included / Compressore d'aria non incluso

Standard version price / Prezzo versioni standard	Price / Prezzo / €	
DEDUST 2	DEDUST2-003	€ 8.789,00

Options / Opzioni	Price / Prezzo / €	
PTFE Antistatic coated Class M filter / Filtro Classe M PTFE Antistatico	FI.0487.0000	+ € 174,00
H13 HEPA Absolute Filter 99,95% / Filtro assoluto Hepa H13 efficienza	TA.1203.0000	+ € 1.370,00
Spark trap kit / Kit spegniscintilla	-	+ € 299,00
TECHFLEX Ø150 L=3000mm - Extraction arm / Braccio articolato	TA.0177.0000	+ € 1.473,00
TECHFLEX Ø200 L=3000mm - Extraction arm / Braccio articolato*	TA.0511.0000	+ € 1.948,00

TA.0177.0000



TA.0511.0000

*Only 1 arm / Solo 1 braccio





Applications: Dry / for light and fine suspended particles of dust
Installation: fixed for central vacuum systems
Material: complete painted steel structure
Filter: polyester antistatic class M with Intelligent automatic filter cleaning system with constant control of filter clogging and performances
Speciality: high airflow dust collector

Applicazione: polveri / per polveri fini in sospensione nell'aria
Ingombro: fisso a pavimento per impianti centralizzati
Materiale: costruzione completa in acciaio verniciato
Filtro: poliestere antistatico classe M con sistema di pulizia automatico dei filtri con controllo costante dell'intasamento e delle prestazioni di filtrazione ed aspirazione
Specialità: depolveratore ad alta portata d'aria

TECHNICAL DATA / DATI TECNICI		DEDUST 4
Voltage / Tensione	V - Hz	400 - 50 3~
Power / Potenza	kW	3
Water Lift min-max / Depressione min-max	mm.H ₂ O	191 - 270
Air Flow max-min / Portata d'aria max-min	M ³ /h	3800 - 2100
Filter surface / Superficie filtrante	Cm ²	4 x 100.000 - 400.000
Filter type / Tipo di filtro		4 x Cartridge / Cartuccia
Ø filter / Ø filtro	mm.	325
Media, class / Media, classe (IEC 60335-2-69) ²		Polyester ANT M
Filter cleaning system / Sistema di pulizia filtri **		Automatic PN / Automatico PN
Solids capacity / Capacità solidi	Lt.	90
Ø Suction inlet / Ø Bocchettone	mm.	1 x 250
Noise level / Rumorosità (EN ISO 3744)	dB(A)	68
Dimensions / Dimensioni	cm.	120x105x230h
Weight / Peso	kg.	350

* Suction inlet not included; different diameters available / Bocchettone aspirazione non incluso; vari diametri disponibili

** Air compressor not included / Compressore d'aria non incluso

Standard version price / Prezzo versioni standard		Price / Prezzo / €
DEDUST 4		DEDUST4-004 € 14.350,00
DEDUST 4 NAKED		DEDUST4-005 € 13.173,00

Options / Opzioni		Price / Prezzo / €
PTFE Antistatic coated Class M filter / Filtro Classe M PTFE Antistatico	FI.0487.0000	+ € 348,00
H13 HEPA Absolute Filter 99,95% / Filtro assoluto Hepa H13 efficienza	-	+ € 1990,00
Spark trap kit / Kit spegniscintilla	-	+ € 520,00
Painted metal kit for Air outlet fan / Kit canalizzazione uscita aria ventilatore	-	on request
TECHFLEX Ø200 L=3000mm - Extraction arm / Braccio articolato	TA.0511.0000	+ € 1.948,00

DEDUST 8



Applications: Dry / for light and fine suspended particles of dust
Installation: fixed for central vacuum systems
Material: complete painted steel structure
Filter: polyester antistatic class M with Intelligent automatic filter cleaning system with constant control of filter clogging and performances
Speciality: high airflow dust collector

Applicazione: polveri / per polveri fini in sospensione nell'aria
Ingombro: fisso a pavimento per impianti centralizzati
Materiale: costruzione completa in acciaio verniciato
Filtro: poliestere antistatico classe M con sistema di pulizia automatico dei filtri con controllo costante dell'intasamento e delle prestazioni di filtrazione ed aspirazione
Specialità: depolveratore ad alta portata d'aria

TECHNICAL DATA / DATI TECNICI		DEDUST 8
Voltage / Tensione	V - Hz	400 - 50 3~
Power / Potenza	kW	5,5
Water Lift max-min. / Depressione max-min.	mm.H ₂ O	350 - 245
Air Flow max-min. / Portata d'aria max-min.	M ³ /h	5400 - 3000
Filter surface / Superficie filtrante	Cm ²	8 x 100.000 - 800.000
Filter type / Tipo di filtro		8 x Cartridge / Cartuccia
Ø filter / Ø filtro	mm.	325
Media, class / Media, classe (IEC 60335-2-69) ²		Polyester ANT M
Filter cleaning system / Sistema di pulizia filtri **		Automatic PN / Automatico PN
Solids capacity / Capacità solidi	Lt.	90
Ø Suction inlet / Ø Bocchettone	mm.	1 x 300
Noise level / Rumorosità (EN ISO 3744)	dB(A)	73
Dimensions / Dimensioni	cm.	120x105x325h
Weight / Peso	kg.	465

* Suction inlet not included; different diameters available / Bocchettone aspirazione non incluso; vari diametri disponibili

** Air compressor not included / Compressore d'aria non incluso

Standard version price / Prezzo versioni standard	Price / Prezzo / €	
DEDUST 8	DEDUST8-001	€ 18.293,00

Options / Opzioni	Price / Prezzo / €	
PTFE Antistatic coated Class M filter / Filtro Classe M PTFE Antistatico	FI.0502.0000	+ € 696,00
H13 HEPA Absolute Filter 99,95% / Filtro assoluto Hepa H13 efficienza		+ € 2.390,00
Spark trap kit / Kit spegniscintilla		+ € 526,00
Painted metal kit for Air outlet fan / Kit canalizzazione uscita aria ventilatore		on request

FUMEBUSTER

WELDING FUME EXTRACTORS *ASPIRAFUMI DI SALDATURA*

FUMEBUSTER



FUMEVAC





Applications: Fumes / gas / vapors produced during processes

Installation: Mobile

Material: Complete painted steel structure

Filter: 3 stages of progressive filtration with Led indicator for filter saturation detection

Speciality: Welding fume extractors with self supporting extraction arm 2mt.

Applicazione: Fumi / vapori / gas sprigionati durante le lavorazioni

Ingombro: Facile da trasportare

Materiale: Costruzione completa in acciaio verniciato

Filtro: 3 stadi filtrazione progressiva con indicatore Led per rilevazione saturazione filtro

Specialità: Aspirafumi di saldatura con braccio autoportante 2mt. ruotabile a 360°

TECHNICAL DATA / DATI TECNICI		FUMEBUSTER PRO
Voltage / Tensione	V - Hz	230 - 50 1~
Power / Potenza	kW	0,55
Air Flow max-min. / Portata d'aria max-min.	M ³ /h	850
Filtration Efficiency / Efficienza di filtrazione		E12 99,5%
1°stage filtration / 1° stadio filtrazione		G4 mesh filter / Prefiltro G4 a rete metallica
2°stage filtration / 2° stadio filtrazione		Main filter E12 14 m ²
3°stage filtration / 3° stadio filtrazione		Active carbon / Carboni attivi 3,3 kg
Ø Suction inlet / Ø Bocchettone	mm.	150
Noise level / Rumorosità (EN ISO 3744)	dB(A)	65
Dimensions / Dimensioni	cm.	43 x 43 x 83h
Weight / Peso	kg.	65

Standard version price / Prezzo versioni standard		Price / Prezzo / €
FUMEBUSTER PRO with included self supporting extraction arm 2mt.	FUMEBUSTERPRO-001	€ 2.505,00

Spare parts / Ricambi	Price / Prezzo / €	
Pre-filter G4 / Pre-filtro G4	FI.0634.0000	€ 155,00
Main filter E12 14m ² / Filtro principale E12 14m ²	FI.0635.0000	€ 422,00
Active carbon filter 13,3Kg / Filtro carboni attivi 13,3Kg	FI.0636.0000	€ 145,00

FUMEBUSTER H - AC



Applications: Fumes / gas / vapors produced during processes

Installation: Mobile

Material: Complete painted steel structure

Filter: 4 stages of progressive filtration with Led indicator for filter saturation detection

Speciality: Welding fume extractors with self supporting extraction arm 3mt.

Applicazione: Fumi / vapori / gas sprigionati durante le lavorazioni

Ingombro: Facile da trasportare

Materiale: Costruzione completa in acciaio verniciato

Filtro: 4 stadi filtrazione progressiva con indicatore Led per rilevazione saturazione filtro

Specialità: Aspirafumi di saldatura con braccio autoportante 3mt. ruotabile a 360°

TECHNICAL DATA / DATI TECNICI		FUMEBUSTER H	FUMEBUSTER AC
Voltage / Tensione	V - Hz	400 - 50 3~	
Power / Potenza	kW	1,1	1,5
Air Flow max-min. / Portata d'aria max-min.	M ³ /h	1300	
Filtration efficiency / Efficienza di filtrazione		H13 99,95%	F9 95%
1°stage filtration / 1° stadio filtrazione		Metallic filter with anti-spark trap / Filtro metallico antiscintilla	
2°stage filtration / 2° stadio filtrazione		G4 fireproof pre-filter / Prefiltro G4 ignifugo	
3°stage filtration / 3° stadio filtrazione		Main filter F7 9m ²	Main filter F9 25m ²
4°stage filtration / 4° stadio filtrazione		Hepa H13 25m ²	Active Carbon / Carboni attivi 12Kg
Ø Suction inlet / Ø Bocchettone	mm.	150	
Noise level / Rumorosità (EN ISO 3744)	dB(A)	72	72
Dimensions / Dimensioni	cm.	65 x 75 x 113h	65 x 75 x 129h
Weight / Peso	kg.	123	131

Standard version price / Prezzo versioni standard	Price / Prezzo / €	
FUMEBUSTER H with included self supporting extraction arm 3mt.	FUMEBUSTER-001	€ 3.215,00
FUMEBUSTER AC with included self supporting extraction arm 3mt.	FUMEBUSTER-002	€ 3.950,00

Spare parts / Ricambi	Price / Prezzo / €	
Pre-filter G4, 10 Pieces set / Pre-filtro G4, set 10 pezzi	FI.0550.0000	€ 85,00
Main filter F7 9m ² / Filtro principale F7 9m ²	FI.0551.0000	€ 246,00
Main filter F9 25m ² / Filtro principale F9 25m ²	FI.0553.0000	€ 410,00
H13 filter 25m ² / Filtro H13 25m ²	FI.0552.0000	€ 539,00
Active carbon filter 12Kg / Filtro carboni attivi 12Kg	FI.0554.0000	€ 336,00



TA.0678.0000 Extractor hood with magnetic holder upon request / Terminale cappa con supporto magnetico su richiesta

Applications: Industrial vacuums for welding fumes at the source on mig-mag welders

Filter: Filtration of fumes and harmful substances

Speciality: With remote control, Dustop filter cleaning system using pressure differential

Applicazione: Aspiratore per fumi di saldatura alla fonte su saldatrici mig-mag

Filtro: Filtrazione dei fumi e delle sostanze nocive

Specialità: Con controllo remoto per accensione e spegnimento automatici, sistema Dustop per la pulizia del filtro tramite pressione differenziale

TECHNICAL DATA / DATI TECNICI		FUMEVAC	FUMEVAC 2
Voltage / Tensione	V - Hz	230 - 50 1~	
Power / Potenza	kW	1,1	2,2
Water Lift max. / Depressione max.	mm.H ₂ O	2.400	
Air Flow max. / Portata d'aria max.	M ³ /h	180	360
Pre-filter / Prefiltro		Anti-spark trap / Antiscintilla	
Primary filter / Filtro primario		Cartridge / Cartuccia	
Filter surface / Superficie filtrante	Cm ²	7.500	
Ø filter / Ø filtro	mm.	245	
Media, class / Media, classe (IEC 60335-2-69)		Polyester - M	
Cleaning system / Sistema di pulizia		Dustop	
Optional filter / Filtro opzionale		Hepa H14 99,995% efficiency	
Filter surface / Superficie del filtro	Cm ²	20.500	
Tank capacity / Capacità contenitore	Lt.	13	
Ø Suction inlet / Ø Bocchettone	mm.	50	
Noise level / Rumorosità (EN ISO 3744)	dB(A)	74	76
Dimensions / Dimensioni	cm.	40 x 56 x 86h	
Weight / Peso	kg.	25	

Standard version price / Prezzo versioni standard	Price / Prezzo / €	
FUMEVAC	FUMEVAC-001	€ 1.583,00
FUMEVAC 2	FUMEVAC2-001	€ 1.749,00

Optionals / Opzioni	Price / Prezzo / €	
H14 absolute filter / Filtro assoluto H14	H	+ € 244,00
Activated carbon filter / Filtro a carboni attivi	AC	+ € 244,00
Extraction hood Ø50 / Cappa aspirazione Ø50	HOOD	+ € 162,00

Recommended accessory / Accessori consigliati	Price / Prezzo / €	
Recommended accessory kit DRY Ø40 / Kit accessori polveri consigliato Ø40	TA.0526.0000	€ 139,00



ATEX

ATEX VACUUMING & DUST COLLECTION SOLUTIONS *SOLUZIONI DI ASPIRAZIONE CERTIFICATE ATEX*

ATEX Z22



METAL POWDERS



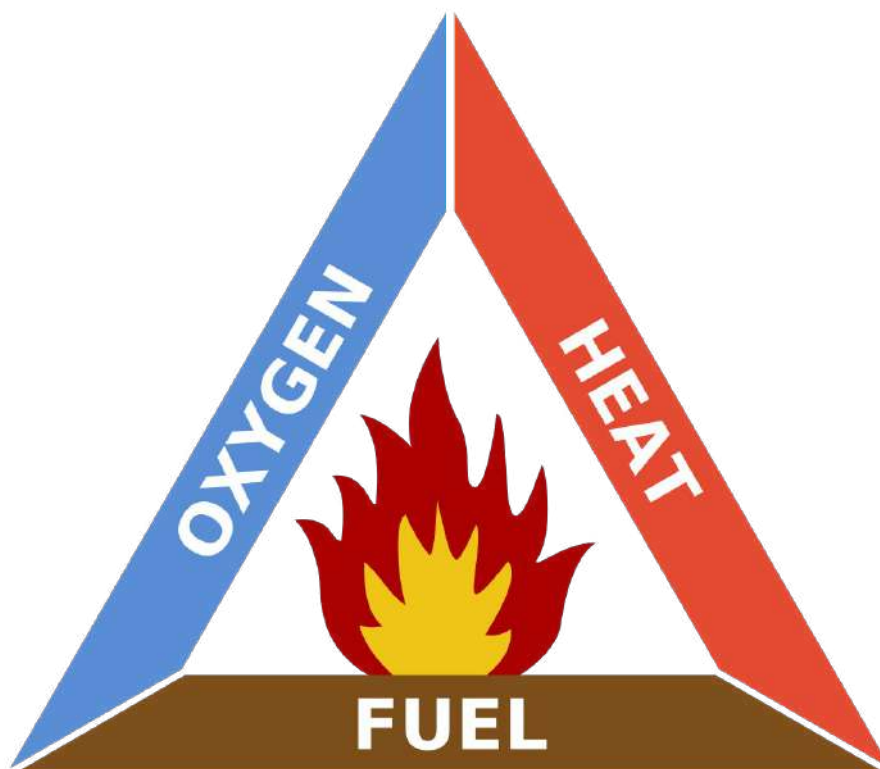

We've developed protection solutions that can meet the customer's needs through the use of:

- Venting membranes
- Vent valves with flame breakers
- Non-return flap valve

Abbiamo sviluppato soluzioni di protezione che possono soddisfare le esigenze del cliente tramite l' utilizzo di:

- Membrane di sfogo
- Valvole di sfogo con rompifiamma
- Valvola flap di non ritorno

Compact and portable industrial vacuum cleaner

Atex Z22 certified version, equipped with a powerful brushless motor, maintenance free.

100% Steel construction.

Suitable for wet, dry and dust applications at the same time.

High capacity detachable container stainless steel AISI 304 with possibility of use disposable bags.

Filter clogging detector and integrated filter cleaning system.

Aspiratore industriale compatto ad alta mobilità

Versione certificata Atex Z22, dotata di un potente motore brushless esente da manutenzione.

Costruzione 100% acciaio.

Possibilità di aspirare contemporaneamente polveri, liquidi e solidi.

Contenitore in acciaio inox AISI 304 a sgancio rapido, con possibilità di insaccamento.

Indicatore di intasamento del filtro e sistema di pulizia manuale integrato.

TECHNICAL DATA / DATI TECNICI		Ex	W 2 XR Z22
Atex zone / Zona Atex			22
Marking / Marcatura			Ex II 3D Ex tc IIIB T135°C X Dc
Electrical protection / Protezione elettrica	IP		55
Voltage / Tensione	V - Hz		230 - 50 1~
Power / Potenza	kW		1,1
Water Lift max. / Depressione max.	mm.H ₂ O		2.250
Air Flow max. / Portata d'aria max.	M ³ /h		215
Filter surface / Superficie filtrante	Cm ²		20.000
Filter type / Tipo di filtro			Star / Tasche
Ø filter / Ø filtro	mm.		420
Filter efficiency / Efficienza filtro	Cat (BIA)		M ANT
Tank capacity / Capacità contenitore	Lt.		40
Ø Suction inlet / Ø Bocchettone	mm.		50
Noise level / Rumorosità (EN ISO 3744)	dB(A)		78
Dimensions / Dimensioni	cm.		63x57x116h
Weight / Peso	kg.		42

Atex version price / Prezzo versioni Atex	Ex	Price / Prezzo / €	
W 2 XR Z22		W2Z22-001	€ 3.025,00

Options / Opzioni	Price / Prezzo / €	
Accessory basket / Cestino portaccessori	AB	+ € 83,00
PTFE Antistatic coated Class M filter / Filtro Antistatico Classe M PTFE	PTFE ANT	+ € 96,00
H14 Absolute filter kit / Filtro assoluto Hepa H14	H14	+ € 248,00
Stainless steel AISI 304 filter chamber / Camera in acciaio inox AISI 304	XX	+ € 400,00
Pneumatic remote control / Controllo da remoto pneumatico	PN/SIST	+ € 576,00

Recommended accessory / Accessori consigliati	Ex	Price / Prezzo / €	
Recommended Antistatic accessory kit WD Ø40 / Kit accessori antistatico WD Ø40 consigliato		TA.0230.0000	€ 238,00





Three-phase industrial vacuum cleaner equipped with side channel blower for continuous work, maintenance free.

Atex Z22 certified version, suitable for wet, dry and dust applications.

Detachable container.

Large filter surface with integrated filter cleaning system.

Aspiratore industriale compatto dotato di turbina a canale laterale per il servizio continuativo.

Versione certificata Atex Z22, prestazioni costanti senza necessità di manutenzioni.

Aspirazione simultanea di polveri, liquidi, solidi.

Contenitore in acciaio a sgancio.

Filtro di ampia superficie con sistema di pulizia manuale integrato.

TECHNICAL DATA / DATI TECNICI		W 2 Infini M Z22	W 2 Infini T Z22
Atex zone / Zona Atex		22	22
Marking / Marcatura		Ex II 3D Ex tc IIIB T135°C X Dc	
Electrical protection / Protezione elettrica	IP	55	
Voltage / Tensione	V - Hz	230 - 50 1~	400 - 50 3~
Power / Potenza	kW	1,8	1,8
Water Lift max. / Depressione max. *	mm.H ₂ O	1.800	1.800
Air Flow max. / Portata d'aria max.	M ³ /h	250	250
Filter surface / Superficie filtrante	Cm ²	20.000	
Filter type / Tipo di filtro		Star / Tasche	
Ø filter / Ø filtro	mm.	420	
Filter efficiency / Efficienza filtro	Cat (BIA)	M ANT	
Tank capacity / Capacità contenitore	Lt.	40	
Ø Suction inlet / Ø Bocchettone	mm.	50	
Noise level / Rumorosità (EN ISO 3744)	dB(A)	73	
Dimensions / Dimensioni	cm.	63x58x130h	
Weight / Peso	kg.	59	60

*Max Waterlift with safety valve installed / Depressione massima con valvola di sicurezza montata.

Atex version price / Prezzo versioni Atex	Price / Prezzo / €	
W 2 Infini M Z22	W2INFINIZ22-002	€ 3.069,00
W 2 Infini T Z22	W2INFINIZ22-004	€ 2.891,00

Options / Opzioni	Price / Prezzo / €	
Accessory basket / Cestino portaccessori	AB	+ € 83,00
PTFE Antistatic coated Class M filter / Filtro Antistatico Classe M PTFE	PTFE ANT	+ € 96,00
H14 Absolute filter kit / Filtro assoluto Hepa H14	H14	+ € 367,00
Stainless steel AISI 304 tank / Contenitore in acciaio inox AISI 304	X	+ € 254,00
Stainless steel AISI 304 tank and filter chamber / Contenitore e camera in acciaio inox AISI 304	XX	+ € 654,00

Recommended accessory / Accessori consigliati	Price / Prezzo / €	
Recommended Antistatic accessory kit WD Ø40 / Kit accessori antistatico WD Ø40 consigliato	TA.0230.0000	€ 238,00



W 3 INFINI 2,2kW Z22 - W 3 INFINI 4kW Z22

Powerful Three-phase industrial vacuum cleaner equipped with side channel blower for continuous work, maintenance free.

Atex Z22 certified version, suitable for wet, dry and dust applications.

Detachable container with possibility to use disposable bags.

Large filter surface with integrated filter cleaning system.

Aspiratore industriale trifase dotato di potente turbina a canale laterale per il servizio continuativo.

Versione certificata Atex Z22, prestazioni costanti senza necessità di manutenzioni.

Aspirazione simultanea di polveri, liquidi, solidi.

Contentore a sgancio con possibilità di insaccamento.

Filtro di ampia superficie con sistema di pulizia manuale integrato.

TECHNICAL DATA / DATI TECNICI			
		W 3 Infini 2,2kW Z22	W 3 Infini 4kW Z22
Atex zone / Zona Atex		22	22
Marking / Marcatura		Ex II 3D Ex tc IIIB T135°C X Dc	
Electrical protection / Protezione elettrica	IP	55	
Voltage / Tensione	V - Hz	400 - 50 3~	400 - 50 3~
Power / Potenza	kW	2,2	4
Water Lift max. / Depressione max. *	mm.H ₂ O	1.900	2.600
Air Flow max. / Portata d'aria max.	M ³ /h	320	420
Filter surface / Superficie filtrante	Cm ²	20.000	
Filter type / Tipo di filtro		Star / Tasche	
Ø filter / Ø filtro	mm.	420	
Filter efficiency / Efficienza filtro	Cat (BIA)	M ANT	
Tank capacity / Capacità contenitore	Lt.	65 / 100	
Ø Suction inlet / Ø Bocchettone	mm.	80	
Noise level / Rumorosità (EN ISO 3744)	dB(A)	73	
Dimensions / Dimensioni	cm.	108x62x137h	
Weight / Peso	kg.	106	121

*Max Waterlift with safety valve installed / Depressione massima con valvola di sicurezza montata.

Atex version price / Prezzo versioni Atex			Price / Prezzo / €
W 3 Infini 2,2kW Z22 - 65lt.	W3INFINIZ22-003		€ 3.542,00
W 3 Infini 4kW Z22 - 65lt.	W3INFINIZ22-001		€ 4.206,00
W 3 Infini 2,2kW Z22 - 100lt.	W3INFINIZ22-012		€ 3.658,00
W 3 Infini 4kW Z22 - 100lt.	W3INFINIZ22-013		€ 4.322,00

Options / Opzioni			Price / Prezzo / €
PTFE Antistatic coated Class M filter / Filtro Antistatico Classe M PTFE	PTFE ANT		+ € 96,00
26500 cm ² - H14 Absolute filter kit / Filtro assoluto Hepa H14	H14		+ € 380,00
Stainless steel AISI 304 tank / Contenitore acciaio inox AISI 304	X		+ € 420,00
Stainless steel AISI 304 tank and filter chamber / Contenitore e camera in acciaio inox AISI 304	XX		+ € 802,00

Recommended accessory / Accessori consigliati			Price / Prezzo / €
Recommended Antistatic accessory kit WD Ø50 / Kit accessori antistatico WD Ø50 consigliato	TA.0626.0000		€ 335,00



Three-phase industrial vacuum cleaner

Atex Z22 certified version.

High filtration efficiency, filter efficiency detector, integrated filter cleaning system.

Maintenance free motor suitable for continuous duty 24/7 work.

Detachable container with possibility to use disposable bags.

Possibility to vacuum dust, solid material, liquids at the same time.

Extremely silent.

Aspiratore industriale trifase

Versione certificata Atex Z22.

Alto livello di filtrazione, indicatore efficienza filtro, pulizia del filtro integrata.

Motore idoneo a servizio continuativo 24/7, senza necessità di manutenzione.

Contentore a sgancio di grande capacità con possibilità di insaccamento.

Aspirazione simultanea di solidi, polveri e liquidi.



Massima silenziosità.

TECHNICAL DATA / DATI TECNICI		M50 Z22	M50 HV Z22	M70 Z22	M90 Z22
Atex zone / Zona Atex		22			
Marking / Marcatura		Ex II 3D Ex tc IIIB T135°C X Dc			
Electrical protection / Protezione elettrica	IP	55			
Voltage / Tensione	V - Hz	400 - 50 3~	400 - 50 3~	400 - 50 3~	400 - 50 3~
Power / Potenza	kW	4	4,3	5,5	7,5*
Water Lift max. / Depressione max. **	mm.H ₂ O	2.600	3.600	3.000	2.700
Air Flow max. / Portata d'aria max.	M ³ /h	420	320	530	700
Filter surface / Superficie filtrante	Cm ²	20.000		35.000	
Filter type / Tipo di filtro		Star / Tasche			
Ø filter / Ø filtro	mm.	420			
Filter efficiency / Efficienza filtro	Cat (BIA)	M ANT			
Tank capacity / Capacità contenitore	Lt.	100			
Ø Suction inlet / Ø Bocchettone	mm.	80			
Noise level / Rumorosità (EN ISO 3744)	dB(A)	74	75	74	77
Dimensions / Dimensioni	cm.	119x65x160h		119x65x180h	
Weight / Peso	kg.	138	146	150	183

*Star-delta starting panel board included / Quadro elettrico avviamento stella-triangolo incluso.

**Max Waterlift with safety valve installed / Depressione massima con valvola di sicurezza montata.

Atex version price / Prezzo versioni Atex	Price / Prezzo / €	
M50 Z22	M50Z22-001	€ 5.302,00
M50 HV Z22	M50HVZ22-001	€ 5.876,00
M70 Z22	M70Z22-001	€ 5.938,00
M90 Z22	M90Z22-001	€ 9.655,00

Options / Opzioni	Price / Prezzo / €	
Longopack 20mt bag container / <i>Contenitore insaccamento longopack 20mt</i>	LP	+ € 716,00
Steel ring for suction into disposable bags / <i>Anello in acciaio fermasacco</i>	SR	+ € 81,00
Pressure differential kit for use of disposable bag / <i>Kit depressore per longopack</i>	PD	+ € 174,00
(M50 Z22 - M50HV Z22 - M70 Z22) Automatic filter shaker with pneumatic Cylinder with Timer and Push Button <i>Scuotifiltro automatico temporizzato con cilindro pneumatico ad aria compressa</i>		AUT + € 2.525,00
(M90 Z22) Automatic filter shaker with pneumatic Cylinder with Timer and Push Button <i>Scuotifiltro automatico temporizzato con cilindro pneumatico ad aria compressa</i>		AUT + € 1.297,00
(M50 Z22) PTFE Antistatic coated Class M filter / <i>Filtro Antistatico Classe M PTFE</i>	PTFE ANT	+ € 96,00
(M50 Z22) - 26500 cm ² H14 Absolute filter kit / <i>Filtro assoluto Hepa H14</i>	H14	+ € 380,00
(M70 Z22 - M90 Z22) PTFE Antistatic coated Class M filter / <i>Filtro Antistatico Classe M PTFE</i>	PTFE ANT	+ € 183,00
(M70 Z22 - M90 Z22) - 52000 cm ² H14 Absolute filter kit / <i>Filtro assoluto Hepa H14</i>	H14	+ € 566,00
Stainless steel AISI 304 tank / <i>Contenitore acciaio inox AISI 304</i>	X	+ € 419,00
(M50 Z22) Stainless steel AISI 304 tank and filter chamber / <i>Contenitore e camera in acciaio inox AISI 304</i>	XX	+ € 843,00
(M70 Z22 - M90 Z22) Stainless steel AISI 304 tank and filter chamber / <i>Contenitore e camera in acciaio inox AISI 304</i>	XX	+ € 1.074,00
Ciclone per protezione filtro / <i>Cyclon for filter protection</i>	CYC	+ € 154,00
Silenziatore supplementare / <i>Additional silencer</i>	ADD/SIL	+ € 150,00
Predisposizione inforcaimento muletto/ <i>Forklift intakes</i>	FORK/INT	+ € 214,00

Recommended accessory / Accessori consigliati	Price / Prezzo / €	
(M Z22 Series) - Recommended Antistatic accessory kit WD Ø50 / <i>Kit accessori antistatico WD Ø50 consigliato</i>	TA.0626.0000	€ 335,00
(M Z22 Series) - Recommended Antistatic accessory kit Dry Ø50 / <i>Kit accessori antistatico Dry Ø50 consigliato</i>	TA.0625.0000	€ 335,00

TA.0626.0000



TA.0625.0000





Heavy Duty Three-phase industrial vacuum cleaner suitable for mobile services or fixed central vacuum systems.

Atex Z22 certified version.

High filtration efficiency , filter efficiency detector, integrated filter cleaning system. Maintenance free motor suitable for continuous duty 24/7 work. Large capacity detachable container.

Forklift intakes for easy transport.

Possibility to vacuum dust, solid material, liquids at the same time.

Extremely silent.

Aspiratore industriale trifase per applicazioni pesanti sia in servizio mobile che su impianti centralizzati.

Versione certificata Atex Z22.

Alto livello di filtrazione, indicatore efficienza filtro, pulizia del filtro integrata.

Motore idoneo a servizio continuativo 24/7, senza necessità di manutenzione.

Contenitore a sgancio a grande capacità. Inforcabile con muletto.

Aspirazione simultanea di solidi, polveri e liquidi.

Massima silenziosità.

TECHNICAL DATA / DATI TECNICI		Ex			
		MHD 100 Z22	MHD 130 Z22	MHD 150 Z22	MHD 200 Z22
Atex zone / Zona Atex		22			
Marking / Marcatura		Ex II 3D Ex tc IIIB T135°C X Dc			
Electrical protection / Protezione elettrica	IP	55			
Voltage / Tensione	V - Hz	400 - 50 3~	400 - 50 3~	400 - 50 3~	400 - 50 3~
Power / Potenza	kW	7,5	11	12,5	18,5
Water Lift max. / Depressione max. *	mm.H ₂ O	3.200	2.600	2.900	3.200
Air Flow max. / Portata d'aria max.	M ³ /h	750	1.050	1.100	1.350
Filter surface / Superficie filtrante	Cm ²	70.000			
Filter type / Tipo di filtro		Star / Tasche			
Ø filter / Ø filtro	mm.	560			
Filter efficiency / Efficienza filtro	Cat (BIA)	M ANT			
Tank capacity / Capacità contenitore	Lt.	160			
Ø Suction inlet / Ø Bocchettone	mm.	120			
Noise level / Rumorosità (EN ISO 3744)		74	75	78	81
Dimensions / Dimensioni	cm.	163x76x200h			
Weight / Peso	kg.	333	410	431	431

*Max Waterlift with safety valve installed / Depressione massima con valvola di sicurezza montata.

Atex version price / Prezzo versioni Atex	Ex		Price / Prezzo / €
MHD 100 Z22			MHD100Z22-002 € 13.704,00
MHD 130 Z22 - NEW			MHD130Z22-001 € 15.734,00
MHD 150 Z22			MHD150Z22-001 € 17.313,00
MHD 200 Z22			MHD200Z22-001 € 19.738,00



Heavy Duty Three-phase industrial vacuum cleaner suitable for mobile services or fixed central vacuum systems.

Atex Z22 certified version.

High filtration efficiency , filter efficiency detector, integrated filter cleaning system. Maintenance free motor suitable for continuous duty 24/7 work. Large capacity detachable container.

Forklift intakes for easy transport.

Possibility to vacuum dust, solid material, liquids at the same time.

Extremely silent.

Aspiratore industriale trifase per applicazioni pesanti sia in servizio mobile che su impianti centralizzati.

Versione certificata Atex Z22.

Alto livello di filtrazione, indicatore efficienza filtro, pulizia del filtro integrata.

Motore idoneo a servizio continuativo 24/7, senza necessità di manutenzione.

Contenitore a sgancio a grande capacità. Inforcabile con muletto.



Aspirazione simultanea di solidi, polveri e liquidi.

Massima silenziosità.

TECHNICAL DATA / DATI TECNICI		MHD 130HV Z22 MHD 180HV Z22 MHD 250HV Z22		
Atex zone / Zona Atex		22		
Marking / Marcatura		Ex II 3D Ex tc IIIB T135°C X Dc		
Electrical protection / Protezione elettrica	IP	55		
Voltage / Tensione	V - Hz	400 - 50 3~	400 - 50 3~	400 - 50 3~
Power / Potenza	kW	11	17,3	20
Water Lift max. / Depressione max. *	mm.H ₂ O	4.300	5.400	5.000
Air Flow max. / Portata d'aria max.	M ³ /h	520	720	1.100
Filter surface / Superficie filtrante	Cm ²	70.000		
Filter type / Tipo di filtro		Star / Tasche		
Ø filter / Ø filtro	mm.	560		
Filter efficiency / Efficienza filtro	Cat (BIA)	M ANT		
Tank capacity / Capacità contenitore	Lt.	160		
Ø Suction inlet / Ø Bocchettone	mm.	120		
Noise level / Rumorosità (EN ISO 3744)		78	76	78
Dimensions / Dimensioni	cm.	163x76x200h		
Weight / Peso	kg.	390	421	450

*Max Waterlift with safety valve installed / Depressione massima con valvola di sicurezza montata.

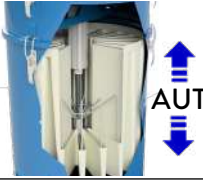
Atex version price / Prezzo versioni Atex	Price / Prezzo / €	
MHD 130HV Z22 - NEW	MHD130HVZ22-001	€ 15.872,00
MHD 180HV Z22	MHD180HVZ22-001	€ 21.181,00
MHD 250HV Z22	MHD250HVZ22-001	€ 23.678,00

Options / Opzioni		Price / Prezzo / €	
PTFE Antistatic coated Class M filter / <i>Filtro Antistatico Classe M PTFE</i>		PTFE ANT	+ € 389,00
Automatic filter shaker with pneumatic Cylinder with Timer and Push Button <i>Scuotifiltro automatico temporizzato con cilindro pneumatico ad aria compressa</i>		AUT	+ € 2.362,00
(MHD 100 Z22 - MHD 180 HV Z22) 52.500 cm² H14 Absolute filter kit / <i>Filtro assoluto Hepa H14</i>		H14	+ € 750,00
(MHD 150 Z22 - MHD 200 Z22) 103.000 cm² H14 Absolute filter kit / <i>Filtro assoluto Hepa H14</i>		H14	+ € 995,00
Stainless steel AISI 304 tank / <i>Contenitore acciaio inox AISI 304</i>		X	+ € 890,00
Stainless steel AISI 304 tank and filter chamber / <i>Contenitore e camera in acciaio inox AISI 304</i>		XX	+ € 2.795,00
Atex remote control / <i>Avviamento locale remoto Atex</i>		RC	+ € 287,00
Lifting bracket and ring for container tipping / <i>Staffa per sollevamento a ribaltamento contenitore</i>		TA.0753.3000	+ € 790,00
Abrasion proof plate in Hardox steel for filter chamber / <i>Piastra rinforzo in Hardox resistente ad abrasione per bocchettone tangenziale della camera filtrante</i>		HARDOX	+ € 360,00
Recommended accessory / Accessori consigliati 		Price / Prezzo / €	
Recommended Antistatic accessory kit WD Ø70 / <i>Kit accessori antistatico WD Ø70 consigliato</i>		TA.1041.0000	€ 592,00



Industrial vacuum cleaner, M and MHD range, PN version

Atex Z22 certified version.

An effective filtration system composed of cartridges with a large filtering surface and an innovative, completely automatic pneumatic cleaning system.

It's particularly suitable for treating large quantities of very fine powders which can clog filtration systems.

Aspiratori industriali serie M e MHD in versione PN

Versione certificata Atex Z22.

Un efficace sistema di filtrazione composto da cartucce ad ampia superficie filtrante con un innovativo sistema di pulizia automatico in contro corrente d'aria.

Particolarmente indicato per trattare polveri molto fini e in quantità cospicue che potrebbero precocemente intasare i comuni sistemi di filtrazione.

TECHNICAL DATA / DATI TECNICI 		M SERIES Z22	MHD SERIES Z22
Atex zone / Zona Atex		22	22
Marking / Marcatura		Ex II 3D Ex tc IIIB T135°C X Dc	
Electrical protection / Protezione elettrica	IP	55	
Superficie filtrante / Filter surface	Cm ²	80.000	106.000
Tipo di filtro / Filter type		3 x Cartridge / Cartucce	4 x Cartridge / Cartucce
Ø filtro / Ø filter	mm.	150	
Efficienza filtro / Filter efficiency	Cat (BIA)	M ANT	

Atex version price / Prezzo versioni Atex 		Price / Prezzo / €	
M50 PN Z22		M50PNZ22-001	€ 8.168,00
M50 HV PN Z22		M50HVPNZ22-001	€ 8.731,00
M70 PN Z22		M70PNZ22-001	€ 8.793,00
M90 PN Z22		M90PNZ22-002	€ 12.513,00
MHD 100 PN Z22		MHD100PNZ22-002	€ 16.797,00
MHD 130 PN Z22 - NEW		MHD130PNZ22-001	€ 18.829,00
MHD 130HV PN Z22 - NEW		MHD130HVPNZ22-001	€ 18.965,00
MHD 150 PN Z22		MHD150PNZ22-001	€ 20.405,00
MHD 180HV PN Z22		MHD180HVPNZ22-001	€ 24.273,00
MHD 200 PN Z22		MHD200PNZ22-001	€ 22.832,00
MHD 250 PN Z22		MHD250PNZ22-001	€ 26.760,00



Air Operated Industrial Vacuum

Atex Z22 certified version.
 100% Steel construction.
 Maintenance free Venturi suction unit
 Suitable for wet, dry and dust applications at the same time.
 High capacity detachable container with possibility of use disposable bags.
 Filter clogging detector and integrated filter cleaning system.

Aspiratore Industriale ad aria compressa

Versione certificata Atex Z22.
 Costruzione 100% acciaio.
 Unità di aspirazione Venturi senza necessità alcuna di manutenzione
 Possibilità di aspirare contemporaneamente polveri, liquidi e solidi.
 Contenitore a sgancio rapido, con possibilità di insaccamento.
 Indicatore di intasamento del filtro e sistema di pulizia manuale integrato.

TECHNICAL DATA / DATI TECNICI		WD 3000 AIR 7V Z22	WD 3000 AIR 14V Z22
Atex zone / Zona Atex		22	
Marking / Marcatura		Ex II 3D Ex tc IIIB T135°C X Dc	
Suction type / Tipologia aspirazione		Venturi	
Ejectors / Ugelli	n.	7	14
Air supply / Alimentazione aria	nlt/min (m ³ /h)	729 (43)	1458 (87)
Water Lift max. / Depressione max.	mm.H ₂ O	3.700	3.700
Air Flow max. / Portata d'aria max.	M ³ /h	150	300
Filter surface / Superficie filtrante	Cm ²	7.000	7.000
Filter type / Tipo di filtro		Bag / Sacco	
Ø filter / Ø filtro	mm.	400	
Media, class / Media, classe (IEC 60335-2-69) ²		M ANT	
Solids capacity / Capacità solidi	Lt.	60	
Ø Suction inlet / Ø Bocchettone	mm.	50	
Noise level / Rumorosità (EN ISO 3744)	dB(A)	78	
Dimensions / Dimensioni	cm.	72x56x94h	
Weight / Peso	kg.	29	30

Standard version price / Prezzo versioni standard		Price / Prezzo / €	
WD 3000 AIR 7V Z22		WD3000AIR7VZ22-001	€ 2.245,00
WD 3000 AIR 14V Z22		WD3000AIR14VZ22-001	€ 2.805,00

Recommended accessory / Accessori consigliati		Price / Prezzo / €	
Recommended Antistatic accessory kit WD Ø40 / Kit accessori antistatico WD Ø40 consigliato		TA.0371.0000	€ 238,00
Recommended Antistatic accessory kit Dry Ø40 / Kit accessori antistatico Dry Ø40 consigliato		TA.0230.0000	€ 238,00

TA.0371.0000



TA.0230.0000



Air Operated Industrial Vacuum

Atex Z22 certified version.
 100% Steel construction.
 Maintenance free Venturi suction unit
 Suitable for wet, dry and dust applications at the same time.
 High capacity detachable container with possibility of use disposable bags.
 Integrated filter cleaning system.

Aspiratore Industriale ad aria compressa

Versione certificata Atex Z22.
 Costruzione 100% acciaio.
 Unità di aspirazione Venturi senza necessità alcuna di manutenzione.
 Possibilità di aspirare contemporaneamente polveri, liquidi e solidi.
 Contenitore a sgancio rapido, con possibilità di insaccamento.
 Sistema di pulizia manuale del filtro integrato.

TECHNICAL DATA / DATI TECNICI		Ex	W1 AIR 7V Z22
Atex zone / Zona Atex			Venturi
Marking / Marcatura			Ex II 3D Ex tc IIIB T135°C X Dc
Suction type / Tipologia aspirazione			Venturi
Ejectors / Ugelli	n.		7
Air supply / Alimentazione aria	nlt/min (m ³ /h)		729 (43)
Water Lift max. / Depressione max.	mm.H ₂ O		3.700
Air Flow max. / Portata d'aria max.	M ³ /h		150
Filter surface / Superficie filtrante	Cm ²		8.000
Filter type / Tipo di filtro			Star / Tasche
Ø filter / Ø filtro	mm.		280
Media, class / Media, classe (IEC 60335-2-69)*			Polyester - ANT M
Solids capacity / Capacità solidi	Lt.		15
Noise level / Rumorosità (EN ISO 3744)	dB(A)		78
Dimensions / Dimensioni	cm.		43x40x96h
Weight / Peso	kg.		25

*For other filter media available please consult the W1 options pag.16 / Per altri media filtranti disponibili vedi W1 a pag. 16.

ATEX version price / Prezzo versioni ATEX		Ex	Price / Prezzo / €
W1 AIR 7V Z22			W1AIR7VZ22-001 € 2095,00

Recommended accessory / Accessori consigliati		Ex	Price / Prezzo / €
Recommended Antistatic accessory kit WD Ø40 / Kit accessori antistatico WD Ø40 consigliato			TA.1185.0000 € 238,00

TA.1185.0000

Air Operated Industrial Vacuum

Atex Z22 certified version.
 Suitable for mixed wet and dry applications.
 100% Steel construction.
 Easy discharge container.
 Maintenance free Venturi suction unit.
 Integrated filter cleaning system.

Aspiratore Industriale ad aria compressa

Versione certificata Atex Z22.
 Idoneo ad aspirare polveri/liquidi/solidi.
 Costruzione 100% Acciaio.
 Contenitore a sgancio facilmente svuotabile.
 Unità di aspirazione Venturi senza necessità alcuna di manutenzione.
 Sistema di pulizia filtro integrato.

TECHNICAL DATA / DATI TECNICI		W2 AIR 7V Z22		W2 AIR 14V Z22	
Atex zone / Zona Atex		22			
Marking / Marcatura		Ex II 3D Ex tc IIIB T135°C X Dc			
Suction type / Tipologia aspirazione		Venturi			
Ejectors / Ugelli	n.	7	14		
Air supply / Alimentazione aria	nlt/min (m ³ /h)	729 (43)	1458 (87)		
Water Lift max. / Depressione max.	mm.H ₂ O	3.700	3.700		
Air Flow max. / Portata d'aria max.	M ³ /h	150	300		
Filter surface / Superficie filtrante	Cm ²	7.000	7.000		
Filter type / Tipo di filtro		Star / Tasche			
Ø filter / Ø filtro	mm.	420			
Filter efficiency / Efficienza filtro	Cat (BIA)	M ANT			
Solids capacity / Capacità solidi	Lt.	40			
Ø Suction inlet / Ø Bocchettone	mm.	50			
Noise level / Rumorosità (EN ISO 3744)	dB(A)				78
Dimensions / Dimensioni	cm.	63x57x108h			
Weight / Peso	kg.	39	40		

ATEX version price / Prezzo versioni ATEX		Price / Prezzo / €	
W2 AIR 7V Z22		W2AIR7VZ22-001	€ 2.331,00
W2 AIR 14V Z22		W2AIR14VZ22-001	€ 3.384,00

Recommended accessory / Accessori consigliati		Price / Prezzo / €	
Recommended Antistatic accessory kit WD Ø40 / Kit accessori antistatico WD Ø40 consigliato		TA.0371.0000	€ 238,00
Recommended Antistatic accessory kit Dry Ø40 / Kit accessori antistatico Dry Ø40 consigliato		TA.0230.0000	€ 238,00

TA.0371.0000



TA.0230.0000



Air Operated Industrial Vacuum

Atex Z22 certified version.
 Suitable for mixed wet and dry applications.
 100% Steel construction.
 Easy discharge container.
 Maintenance free Venturi suction unit with 19 or 25 nozzles.
 Integrated filter cleaning system.

Aspiratore Industriale ad aria compressa

Versione certificata Atex Z22.
 Idoneo ad aspirare polveri/liquidi/solidi.
 Costruzione 100% Acciaio.
 Contenitore a sgancio facilmente svuotabile.
 Unità di aspirazione Venturi a 19 o 25 ugelli senza necessità alcuna di manutenzione.
 Sistema di pulizia filtro integrato.

TECHNICAL DATA / DATI TECNICI		W 3 AIR 19 Z22		W 3 AIR 25 Z22	
Atex zone / Zona Atex		22			
Marking / Marcatura		Ex II 3D Ex tc IIIB T135°C X Dc			
Suction type / Tipologia aspirazione		Multi ejectors Venturi / Multi ugelli Venturi			
Ejectors / Ugelli	n.	19	25		
Air supply / Alimentazione aria	nlt/min (m ³ /h)	1.530 (92)	2.500 (150)		
Water Lift max. / Depressione max.	mm.H ₂ O	5.000	5.000		
Air Flow max. / Portata d'aria max.	M ³ /h	465	590		
Filter surface / Superficie filtrante	Cm ²	20.000			
Filter type / Tipo di filtro		Star / Tasche			
Ø filter / Ø filtro	mm.	420			
Filter efficiency / Efficienza filtro	Cat (BIA)	M ANT			
Solids capacity / Capacità solidi	Lt.	65 / 100			
Ø Suction inlet / Ø Bocchettone	mm.	80			
Noise level / Rumorosità (EN ISO 3744)	dB(A)	79			
Dimensions / Dimensioni	cm.	70x62x134h			
Weight / Peso	kg.	65	66		

Atex version price / Prezzo versioni Atex		Price / Prezzo / €	
W 3 AIR 19 65lt Z22		W3AIR19Z22-001	€ 4.679,00
W 3 AIR 25 65lt Z22		W3AIR25Z22-001	€ 5.811,00
W 3 AIR 19 100lt Z22		W3AIR19Z22-002	€ 4.671,00
W 3 AIR 25 100lt Z22		W3AIR25Z22-002	€ 5.914,00

Recommended accessory / Accessori consigliati		Price / Prezzo / €	
Recommended Antistatic accessory kit WD Ø50 / Kit accessori antistatico WD Ø50 consigliato		TA.0626.0000	€ 335,00
Recommended Antistatic accessory kit Dry Ø50 / Kit accessori antistatico Dry Ø50 consigliato		TA.0625.0000	€ 335,00

TA.0626.0000



TA.0625.0000



Vacuumping SILOS: the highest expression of DU-PUY Flexibility

Atex Z22 certified version, designed for large quantities of materials and direct discharge into big-collection baskets.

Collection capacity of 100lt.

Material discharge with tilting flap, butterfly valves, guillotine.

Simplified and fast BIG-BAG bagging system.

High surface dust filter for fine dust with manual shaker.

Mounted on wheels or fixed to the floor.

Sturdy chassis and forklift intakes.

SILOS Aspiranti: la massima espressione di Flessibilità DU-PUY.

Versione certificata Atex Z22, concepiti per l'aspirazione di grosse quantità di materiali e scarico diretto in big-bag o fusti di raccolta.

Capacità di raccolta da 100 lt.

Scarico materiale con valvole a farfalla, ghigliottine, paletta bilanciata.



Insaccamento in BIG-BAG semplificato e rapido.

Filtro ad elevata superficie per polveri fini, dotato di scuotitore manuale. Montati su ruote o fissi a pavimento.

Telaio inforcabile con muletto di serie.

TECHNICAL DATA / DATI TECNICI		SILOVAC 100T Z22
Atex zone / Zona Atex		22
Marking / Marcatura		Ex II 3D Ex tc IIIB T135°C X Dc
Electrical protection / Protezione elettrica	IP	55
Voltage / Tensione	V - Hz	400 - 50 3~
Power / Potenza	kW	3
Water Lift max. / Depressione max. *	mm.H ₂ O	2.000
Air Flow max. / Portata d'aria max.	M ³ /h	370
Filter surface / Superficie filtrante	Cm ²	20.000
Filter type / Tipo di filtro		Star / Tasche
Ø filter / Ø filtro	mm.	420
Media, class / Media, classe (IEC 60335-2-69) ²		M ANT
Tank capacity / Capacità contenitore	Lt.	100
Ø Suction inlet / Ø Bocchettone	mm.	80
Noise level / Rumorosità (EN ISO 3744)	dB(A)	
Discharge system / Sistema di scarico		Butterfly valve Ø150 / Valvola a farfalla Ø150
Silos chassis type / Tipologia chassis		Big-bag chassis / Chassis per scarico in big-bag
Dimensions / Dimensioni	cm.	139x126x315h
Weight / Peso	kg.	171

*Max Waterlift with safety valve installed / Depressione massima con valvola di sicurezza montata.

Atex version price / Prezzo versioni Atex		Price / Prezzo / €
SILOVAC 100T Z22	SILOVAC100TZ22-001	€ 7.365,00
SILOVAC 100T Z22 Wall mounted / Fisso a parete		€ 6.225,00
SILOVAC 100T Z22 For discharging on the floor / Per scarico a pavimento		€ 6.480,00

Other filter media available upon request / Altri media filtranti disponibili a richiesta

Vacuuming SILOS: the highest expression of DU-PUY Flexibility

Atex Z22 certified version, designed for large quantities of materials and direct discharge into big-collection baskets. Collection capacity of 600lt with maximum level detector. Material discharge with tilting flap, butterfly valves, guillotine. Simplified and fast BIG-BAG bagging system. High surface dust filter for fine dust with automatic shaker and compressor. Mounted on telescopic chassis for easy transport. Sturdy chassis and forklift intakes.

SILOS Aspiranti: la massima espressione di Flessibilità DU-PUY

Versione certificata Atex Z22, concepiti per l'aspirazione di grosse quantità di materiali e scarico diretto in big-bag o fusti di raccolta.

Capacità di raccolta da 600 lt con sonda di massimo livello.

Scarico materiale con valvole a farfalla, ghigliottine, paletta bilanciata.

Insaccamento in BIG-BAG semplificato e rapido.

Filtri ad elevate superficie per polveri fini dotato di scuotitore automatico e compressore a bordo macchina.

Montati su telaio telescopico per facile movimentazione. Telaio inforcabile con muletto di serie.

TECHNICAL DATA / DATI TECNICI		SILOVAC 600 Z22	SILOVAC 600AF Z22	SILOVAC 600HV Z22
Atex zone / Zona Atex		22		
Marking / Marcatura		Ex II 3D Ex tc IIIB T135°C X Dc		
Voltage / Tensione	V - Hz	400 - 50 3~	400 - 50 3~	400 - 50 3~
Power / Potenza	kW	12,5	18,5	20
Water Lift max. / Depressione max. *	mm.H ₂ O	2.900	3.200	4.500
Air Flow max. / Portata d'aria max.	M ³ /h	1.100	1.350	1.100
Filter surface / Superficie filtrante	Cm ²	70.000		
Filter type / Tipo di filtro		Star / Tasche		
Ø filter / Ø filtro	mm.	560		
Filter efficiency / Efficienza filtro	Cat (BIA)	M PTFE ANT		
Cleaning system / Sistema di pulizia filtro		Automatic self clean, compressor not included Automatico, compressore non incluso		
Safety filter / Filtro di sicurezza		Cartridge H14 52.000 cm ² / Cartuccia Hepa H14 52.000 cm ²		
Tank capacity / Capacità contenitore	Lt.	600		
Level detector / Sonda di livello massimo		Rotary level detector / Sonda di livello rotante		
Ø Suction inlet / Ø Bocchettone	mm.	100		
Discharge system / Sistema di scarico		Manual butterfly valve Ø250 / Valvola a farfalla manuale Ø250		
Silos chassis type / Tipologia chassis		Telescopic big-bag chassis / Chassis per scarico in big-bag telescopico		
Dimensions / Dimensioni	cm.	Low position 135x135x250h - Highest position 135x135x400h		
Weight / Peso	kg.	1015	1025	1125

*Max Waterlift with safety valve installed / Depressione massima con valvola di sicurezza montata.

Atex version price / Prezzo versioni Atex	Price / Prezzo / €	
SILOVAC 600 Z22 - Without compressor / Senza compressore	SILOVAC600Z22-001	€ 32.654,00
SILOVAC 600AF Z22 - Without compressor / Senza compressore	SILOVAC600AFZ22-001	€ 35.552,00
SILOVAC 600HV Z22 - Without compressor / Senza compressore	SILOVAC600HVZ22-001	€ 40.887,00
Options available upon request / Opzioni su richiesta*	Price / Prezzo / €	
ATEX Remote Control / Avviamento locale remoto ATEX	RC	+ € 284,00

*For discharge systems and level detectors, please consult CVS section pag.135
Per sistemi di scarico e sonde di livello disponibili, consultare sezione CVS a pag.135



Filtering SILOS: the highest expression of DU-PUY Flexibility.
 Atex Z22 certified version, connected to a CVAC unit, they are designed for suction of large quantities of materials and direct discharge into big-bags or collection baskets. Collection capacity from 200 to 1000lt. Direct connection with Central vacuum unit from 5,5 up to 25kW. Material discharge with tilting flap, butterfly valves, guillotine, rotovalve. Simplified and fast BIG-BAG bagging system. High surface dust filter for fine dust with manual shaker. Mounted on wheels or fixed to the floor. Sturdy chassis and forklift intakes.

SILOS filtranti: la massima espressione di flessibilità DU-PUY.
 Versione certificata Atex Z22, connessi a una potente centrale aspirante sono concepiti per l'aspirazione di grosse quantità di materiali e scarico diretto in big-bag o fusti di raccolta. Capacità di raccolta da 200 a 1000lt. Possibilità di connessione a turbine canale laterale da 5,5 a 25kW di potenza. Scarico materiale con porta basculante, valvole a farfalla, ghigliottine o rotovalle. Insaccamento in BIG-BAG semplificato e rapido. Filtro ad elevata superficie per polveri fini dotato di scuotitore manuale. Montati su ruote o fissi. Telaio inforcabile con muletto di serie.

TECHNICAL DATA / DATI TECNICI		SILOFILTER200 SILOFILTER600 SILOFILTER1000		
Atex zone / Zona Atex		22		
Marking / Marcatura		Ex II 3D Ex tc IIIB T135°C X Dc		
Electrical protection / Protezione elettrica	IP	55		
Filter surface / Superficie filtrante	Cm ²	50.000*		
Filter type / Tipo di filtro		Star / Tasche		
Ø filter / Ø filtro	mm.	560		
Filter efficiency / Efficienza filtro	Cat (BIA)	M ANT		
Tank capacity / Capacità contenitore	Lt.	200	600	1000
Ø Suction inlet / Ø Bocchettone	mm.	80		
Discharge system / Sistema di scarico		Open flange Ø150 / Flangia aperta Ø150	Open flange Ø250 / Flangia aperta Ø250	
Silos chassis type / Tipologia chassis /		Big-bag chassis / Chassis per scarico in big-bag		
Dimensions / Dimensioni	cm.	143x99x355h	147x108x350h	
Weight / Peso	kg.	290	348	390

* Different filtering surfaces available, base on the CV unit choosen / *Differenti superfici filtranti disponibili a richiesta*

Atex version price / Prezzo versioni Atex	Price / Prezzo / €
SILOFILTER 200 Z22	€ 6.225,00
SILOFILTER 600 Z22	€ 9.730,00
SILOFILTER 1000 Z22	€ 11.570,00

Options available upon request / Opzioni su richiesta*	Price / Prezzo / €
CAT M PTFE ANT - Star filter 50.000cm ² / Filtro a tasche 50.000cm ²	PTFE ANT + € 391,00
(SILOFILTER 600-1000) CAT M ANT - Star filter 70.000cm ² / Filtro a tasche 70.000cm ²	ELF M ANT + € 525,00
(SILOFILTER 600-1000) CAT M PTFE ANT- Star filter 70.000cm ² / Filtro a tasche 70.000cm ²	ELF PTFE ANT + € 963,00
Automatic filter shaker with pneumatic Cylinder with Timer and Push Button <i>Scuotifiltro automatico temporizzato con cilindro pneumatico ad aria compressa</i>	 AUT + € 2.362,00

*For discharge systems and level detectors, please consult CVS section pag.135
 Per sistemi di scarico e sonde di livello disponibili, consultare sezione CVS a pag.135

Certified Atex Z22 filtering SILOS

Connected to a CVAC unit, they are designed for suction of large quantities of materials and direct discharge into big-bags or collection baskets. Collection capacity from 200 to 1000lt. Direct connection with Central vacuum unit from 5,5 up to 25kW. Material discharge with tilting flap, butterfly valves, guillotine, rotovalve. Simplified and fast BIG-BAG bagging system. High surface dust filter for fine dust with automatic filter cleaning system. Mounted on wheels or fixed to the floor. Sturdy chassis and forklift intakes.

SILOS filtranti certificati Atex Z22

Connessi a una potente centrale aspirante sono concepiti per l'aspirazione di grosse quantità di materiali e scarico diretto in big-bag o fusti di raccolta. Capacità di raccolta da 200 a 1000lt. Possibilità di connessione a turbine canale laterale da 5,5 a 25kW di potenza. Scarico materiale con porta basculante, valvole a farfalla, ghigliottine o rotovalle. Insaccamento in BIG-BAG semplificato e rapido. Filtro ad elevata superficie per polveri fini dotato di filtri autopulenti montati su ruote o fissi a pavimento. Telaio inforcabile con muletto di serie.



TECHNICAL DATA / DATI TECNICI		SILOFILTER 200PN Z22	SILOFILTER 600PN Z22	SILOFILTER 1000PN Z22
Atex zone / Zona Atex		22		
Marking / Marcatura		Ex II 3D Ex tc IIIB T135°C X Dc		
Filter type / Tipo di filtro		Cartridge / Cartuccia		
Filter surface / Superficie filtrante	Cm ²	106.000		
Cartridges n° / Numero cartucce		4		
Filter / Filtro	mm.	Ø150 x h700		
Filter efficiency / Efficienza filtro	Cat (BIA)	M ANT		
Tank capacity / Capacità contenitore	Lt.	200	600	1000
Ø Suction inlet / Ø Bocchettone	mm.	80		
Discharge system / Sistema di scarico		Flange Ø150 / Flangia Ø150	Flange Ø250 / Flangia Ø250	
Silos chassis type / Tipologia chassis /		Big-bag chassis / Chassis per scarico in big-bag		
Dimensions / Dimensioni	cm.	143x99x375h	147x108x359h	147x108x390h
Weight / Peso	kg.	330	395	440

Atex version price / Prezzo versioni Atex	Price / Prezzo / €
SILOFILTER 200PN Z22	€ 9.475,00
SILOFILTER 600PN Z22	€ 13.075,00
SILOFILTER 1000PN Z22	€ 14.960,00

For discharge systems and level detectors, please consult CVS section pag.135
 Per sistemi di scarico e sonde di livello disponibili, consultare sezione CVS a pag.135

Options available upon request / Opzioni su richiesta	Price / Prezzo / €
CAT M PTFE ANT - Cartridge filter / Filtro Cartuccia	PTFE ANT + € 457,00



Certified Atex Z22 Filtering SILOS

Connected to a CVAC unit, they are designed for suction of large quantities of materials and direct discharge into big-bags or collection baskets. Collection capacity from 160 to 250lt. Direct connection with Central vacuum unit from 4 up to 25kW. Material discharge with tilting flap, butterfly valves, guillotine, rotovalve.

Simplified and fast BIG-BAG bagging system.

High surface dust filter for fine dust with automatic filter cleaning system.

Sturdy chassis and forklift intakes.

SILOS filtranti certificati Atex Z22

Connessi a una potente centrale aspirante sono concepiti per l'aspirazione di grosse quantità di materiali e scarico diretto in big-bag o fusti di raccolta.

Capacità di raccolta da 160 a 250lt. Possibilità di connessione a turbine canale laterale da 4 a 25kW di potenza. Scarico materiale con porta basculante, valvole a farfalla, ghigliottine o rotocecella.

Insaccamento in BIG-BAG semplificato e rapido.

Filtro ad elevata superficie per polveri fini dotato di sistema autopulente.

Telaio inforcabile con muletto di serie.

TECHNICAL DATA / DATI TECNICI				BAGFILTER 160 Z22	SILOBAG 250 FILTER Z22
Atex zone / Zona Atex		22			
Marking / Marcatura		Ex II 3D Ex tc IIIB T135°C X Dc			
Filter surface / Superficie filtrante	Cm ²	60.000			
Filter type / Tipo di filtro		Round bags sleeves Maniche a sacco			
Ø filter / Ø filtro	mm.	800			
Media, class / Media, classe (IEC 60335-2-69) ²		M ANT Teflon Hydro-Oleophobic			
Cleaning system / Sistema di pulizia filtro		Automatic PN / Automatico PN in controcorrente d'aria			
Tank capacity / Capacità contenitore	Lt.	160	250		
Ø Suction inlet / Ø Bocchettone	mm.	120			
Discharge system / Sistema di scarico		Collector tank / Contenitore	Flange Ø250 / Flangia Ø250		
Silos chassis type / Tipologia chassis		Collector tank / Contenitore	Big-bag chassis / Chassis per scarico in big-bag		
Dimensions / Dimensioni	cm.	101x96x240h	143x99x369h		

Atex version price / Prezzo versioni Atex*				Price / Prezzo / €	
BAGFILTER 160 Z22			€ 16.738,00		
SILOBAG 250 FILTER Z22			€ 19.159,00		

*For discharge systems and level detectors, please consult CVS section pag.135
Per sistemi di scarico e sonde di livello disponibili, consultare sezione CVS a pag.135

Certified Atex Z22 Filtering SILOS

Connected to a CVAC unit, they are designed for suction of large quantities of materials and direct discharge into big-bags or collection baskets. Collection capacity from 600 to 1000lt. Direct connection with Central vacuum unit from 5,5 up to 25kW. Material discharge with tilting flap, butterfly valves, guillotine, rotovalve. Simplified and fast BIG-BAG bagging system. High surface dust filter for fine dust with automatic filter cleaning system. Sturdy chassis and forklift intakes.

SILOS filtranti certificati Atex Z22

Connessi a una potente centrale aspirante sono concepiti per l'aspirazione di grosse quantità di materiali e scarico diretto in big-bag o fusti di raccolta. Capacità di raccolta da 600 a 1000lt. Possibilità di connessione a turbine canale laterale da 5,5 a 25kW di potenza. Scarico materiale con porta basculante, valvole a farfalla, ghigliottine o rotoceffa. Insaccamento in BIG-BAG semplificato e rapido. Filtro ad elevata superficie per polveri fini dotato di sistema autopulente. Telaio inforcabile con muletto di serie.

TECHNICAL DATA / DATI TECNICI		SILOBAG 600 FILTER Z22	SILOBAG 1000 FILTER Z22
Atex zone / Zona Atex		22	
Marking / Marcatura		Ex II 3D Ex tc IIIB T135°C X Dc	
Filter surface / Superficie filtrante	Cm ²	60.000	110.000
Filter type / Tipo di filtro		Round bags sleeves Maniche a sacco	
Ø filter / Ø filtro	mm.	800	1000
Media, class / Media, classe (IEC 60335-2-69) ²		M ANT Teflon Hydro-Oleophobic	
Cleaning system / Sistema di pulizia filtro		Automatic PN / Automatico PN in controcorrente d'aria	
Tank capacity / Capacità contenitore	Lt.	600	1000
Ø Suction inlet / Ø Bocchettone	mm.	80 o 160	
Discharge system / Sistema di scarico		Flange Ø250 / Flangia Ø250	
Silos chassis type / Tipologia chassis		Big-bag chassis / Chassis per scarico in big-bag	
Dimensions / Dimensioni	cm.	143x99x369h	147x108x386h

Atex version price / Prezzo versioni Atex*		Price / Prezzo / €
SILOBAG 600 FILTER Z22		€ 21.794,00
SILOBAG 1000 FILTER Z22		€ 27.205,00

*For discharge systems and level detectors, please consult CVS section pag.135
Per sistemi di scarico e sonde di livello disponibili, consultare sezione CVS a pag.135

Central vacuum units with side channel blowers.

Atex Z22 certified version.

From 4 to 7,5 kW.

Side channel blower and protective carter.

A pressure relief valve is equipped as standard.

CVAC 50 Direct starting, 24 Volt controls and L/R

CVAC 70 - CVAC 90 Δ / Y starting, 24 Volt controls and L/R

The price includes the electrical panel.

Centrali aspiranti con turbine a canale laterale.

Versione certificata Atex Z22.

Da 4 a 7,5 kW.

Pompa di Vuoto a Canale Laterale, Carter di protezione.

Dotati di Valvola limitatrice di vuoto di serie.

CVAC 50 Avviamento diretto, comandi 24 Volt e L/R

CVAC 70 - CVAC 90 Avviamento Δ / Y, comandi 24 Volt e L/R

Il quadro elettrico è incluso nel prezzo.

TECHNICAL DATA / DATI TECNICI		CVAC 50 Z22	CVAC 70 Z22	CVAC90 Z22
Atex zone / Zona Atex		22		
Marking / Marcatura		Ex II 3D Ex tc IIIB T135°C X Dc		
Electrical protection / Protezione elettrica	IP	55		
Voltage / Tensione	V - Hz	400 - 50 3~	400 - 50 3~	400 - 50 3~
Power / Potenza	kW	4	5,5	7,5
Waterlift max. / Depressione max. *	mm.H ₂ O	2.600	3.000	2.700
Air Flow max. / Portata d'aria max.	M ³ /h	420	530	700
Suction inlet / Bocchettone	mm	60	70	
Noise Level / Rumorosità	dB(A)	74	74	77
Dimensions / Dimensioni	cm.	67x63x131h		

Included: electric panel board, pressure relief valve, selector for remote start/stop, noise silencer

Incluso: quadro elettrico, valvola limitatrice di vuoto, settore locale/remoto, silenziatore

*Max Waterlift with safety valve installed / Depressione massima con valvola di sicurezza montata.

Atex version price / Prezzo versioni Atex	Price / Prezzo / €	
CVAC 50 Z22	CVAC50Z22-001	€ 5.302,00
CVAC 70 Z22	CVAC70Z22-001	€ 6.175,00
CVAC 90 Z22	CVAC90Z22-001	€ 8.052,00

Options available upon request / Opzioni su richiesta	Price / Prezzo / €	
Additional silencer / Silenziatore supplementare - Ø90 h535	ADD/SIL	+ € 162,00
Inverter	INV	On Request

Central vacuum units with side channel blowers.

Atex Z22 certified version.

From 7,5 to 18,5 kW.

Side channel blower and protective carter.

A pressure relief valve is equipped as standard.

Electrical panel with direct starting, 24 Volt controls and L/R

The price includes the electrical panel.

Centrali aspiranti con turbine a canale laterale.

Versione certificata Atex Z22.

Da 7,5 a 18,5 kW.

Pompa di Vuoto a Canale Laterale, Carter di protezione.

Dotati di Valvola limitatrice di vuoto di serie.

Pannello elettrico con avviamento diretto, comandi 24 Volt e L/R

Il quadro elettrico è incluso nel prezzo.



TECHNICAL DATA / DATI TECNICI		CVAC 100 Z22	CVAC 130 Z22	CVAC 150 Z22	CVAC 200 Z22
Atex zone / Zona Atex		22			
Marking / Marcatura		Ex II 3D Ex tc IIIB T135°C X Dc			
Electrical protection / Protezione elettrica	IP	55	55	65	65
Voltage / Tensione	V - Hz	400 - 50 3~	400 - 50 3~	400 - 50 3~	400 - 50 3~
Power / Potenza	kW	7,5	11	12,5	18,5
Waterlift max. / Depressione max. *	mm.H ₂ O	3.200	2.600	2.900	3.200
Air Flow max. / Portata d'aria max.	M ³ /h	750	1.050	1.100	1.350
Suction inlet / Bocchettone	mm	100	100	100	100
Noise Level / Rumorosità	dB(A)	74	75	76	81
Dimensions / Dimensioni	cm.	89x78x124h			

Included: electric panel board, pressure relief valve, selector for remote start/stop, noise silencer

Incluso: quadro elettrico, valvola limitatrice di vuoto, settore locale/remoto, silenziatore

*Max Waterlift with safety valve installed / Depressione massima con valvola di sicurezza montata.

Atex version price / Prezzo versioni Atex	Price / Prezzo / €	
CVAC 100 Z22	CVAC100Z22-001	€ 11.444,00
CVAC 130 Z22	CVAC130Z22-001	€ 11.561,00
CVAC 150 Z22	CVAC150Z22-001	€ 12.661,00
CVAC 200 Z22	CVAC200Z22-001	€ 15.398,00

Options available upon request / Opzioni su richiesta	Price / Prezzo / €	
CVAC 100 - In/Out Ø100 Safety cartridge HEPA H14 filter / Filtro di sicurezza HEPA H14 - 52.000cm ² 	H14	+ € 1.012,00
CVAC 130 - CVAC 150 - CVAC 200 - In/Out Ø100 Safety cartridge HEPA H14 filter / Filtro di sicurezza HEPA H14 - 103.000cm ² 	H14	+ € 1.288,00
Additional silencer / Silenziatore supplementare	ADD/SIL	+ € 304,00
Inverter	INV	On Request

Central vacuum units with side channel blowers.

Atex Z22 certified version.

From 20 to 25 kW.

Side channel blower and protective carter.

A pressure relief valve is equipped as standard.

Electrical panel with direct starting, 24 Volt controls and L/R

The price includes the electrical panel.

Centrali aspiranti con turbine a canale laterale.

Versione certificata Atex Z22.

Da 20 a 25 W.

Pompa di Vuoto a Canale Laterale, Carter di protezione.

Dotati di Valvola limitatrice di vuoto di serie.

Pannello elettrico con avviamento diretto, comandi 24 Volt e L/R

Il quadro elettrico è incluso nel prezzo.

TECHNICAL DATA / DATI TECNICI		CVAC 300 Z22
Atex zone / Zona Atex		22
Marking / Marcatura		Ex II 3D Ex tc IIIB T135°C X Dc
Electrical protection / Protezione elettrica	IP	65
Voltage / Tensione	V - Hz	400 - 50 3~
Power / Potenza	kW	25
Waterlift max. / Depressione max. *	mm.H ₂ O	3.200
Air Flow max. / Portata d'aria max.	M ³ /h	2.050
Suction inlet / Bocchettone	mm	130
Noise Level / Rumorosità	dB(A)	78
Dimensions / Dimensioni	cm.	103x93x197h

Included: electric panel board, pressure relief valve, selector for remote start/stop, noise silencer

Incluso: quadro elettrico, valvola limitatrice di vuoto, settore locale/remoto, silenziatore

*Max Waterlift with safety valve installed / Depressione massima con valvola di sicurezza montata.

Atex version price / Prezzo versioni Atex	Price / Prezzo / €	
CVAC 300 Z22	CVAC300Z22-001	€ 26.348,00

Options available upon request / Opzioni su richiesta	Price / Prezzo / €	
CVAC 300 - In/Out Ø130 Safety cartridge HEPA H14 filter / Filtro di sicurezza HEPA H14 - 103.000cm ² 	H14	+ € 1.398,00
Additional silencer / Silenziatore supplementare	ADD/SIL	+ € 390,00
Inverter	INV	On Request

Central vacuum units with side channel blowers.

Atex Z22 certified version.

From 20 to 25 kW.

Side channel blower and protective carter.

A pressure relief valve is equipped as standard.

Electrical panel with direct starting, 24 Volt controls and L/R

The price includes the electrical panel.

Centrali aspiranti con turbine a canale laterale.

Versione certificata Atex Z22.

Da 20 a 25 W.

Pompa di Vuoto a Canale Laterale, Carter di protezione.

Dotati di Valvola limitatrice di vuoto di serie.

Pannello elettrico con avviamento diretto, comandi 24 Volt e L/R

Il quadro elettrico è incluso nel prezzo.



TECHNICAL DATA / DATI TECNICI		CVAC 130HV Z22	CVAC 180HV Z22	CVAC 250HV Z22
Atex zone / Zona Atex		22		
Marking / Marcatura		Ex II 3D Ex tc IIIB T135°C X Dc		
Electrical protection / Protezione elettrica	IP	55	65	
Voltage / Tensione	V - Hz	400 - 50 3~	400 - 50 3~	400 - 50 3~
Power / Potenza	kW	11	17,3	20
Waterlift max. / Depressione max. *	mm.H ₂ O	4.300	5.400	4.400
Air Flow max. / Portata d'aria max.	M ³ /h	520	720	1.100
Suction inlet / Bocchettone	mm	70	100	
Noise Level / Rumorosità	dB(A)	74	77	78
Dimensions / Dimensioni	cm.	89x78x124h		103x93x197h

Included: electric panel board, pressure relief valve, selector for remote start/stop, noise silencer

Incluso: quadro elettrico, valvola limitatrice di vuoto, settore locale/remoto, silenziatore

*Max Waterlift with safety valve installed / Depressione massima con valvola di sicurezza montata.

Atex version price / Prezzo versioni Atex	Price / Prezzo / €	
CVAC 130 HV Z22	CVAC130HVZ22-001	€ 11.697,00
CVAC 180 HV Z22	CVAC180HVZ22-001	€ 16.427,00
CVAC 250 HV Z22	CVAC250HVZ22-001	€ 23.129,00

Options available upon request / Opzioni su richiesta		Price / Prezzo / €	
CVAC 130HV - CVAC 180HV - In/Out Ø100 Safety cartridge HEPA H14 filter / Filtro di sicurezza HEPA H14 - 52.000cm ²		H14	+ € 1.012,00
CVAC 250HV - In/Out Ø100 Safety cartridge HEPA H14 filter / Filtro di sicurezza HEPA H14 - 103.000cm ²		H14	+ € 1.288,00
CVAC 130HV - CVAC 180HV - Additional silencer / Silenziatore supplementare		ADD/SIL	+ € 307,00
CVAC 250HV - Additional silencer / Silenziatore supplementare		ADD/SIL	+ € 390,00
Inverter		INV	On Request



Atex Z22 Compact and portable industrial vacuum cleaner
 100% Steel construction. Vacuum cleaner for suction and inerting of explosive combustible dust.
 The Atex Z22 version is equipped with a powerful Brushless motor, maintenance free.
 Certified to vacuum combustible and conductive powders (Metal powders).

Aspiratore industriale compatto Atex Z22 ad alta mobilità per polveri combustibili

Costruzione 100% acciaio. Possibilità di aspirare contemporaneamente polveri combustibili con sistema di immersione in fluido inertizzante.
 Versione certificata Atex Z22 è equipaggiata di un potente motore brushless, esente da manutenzione.
 Certificato per l'aspirazione di polveri combustibili e conduttive (polveri metalliche).

TECHNICAL DATA / DATI TECNICI		SEP.EX-001		W2 XR Z22 MDI	
Atex zone / Zona Atex		22			
Marking / Marcatura		Ex II 3D Ex h IIIC T85°C Dc (of inerting container)			
Electrical protection / Protezione elettrica	IP	-	55		
Voltage / Tensione	V - Hz	-	230 - 50 1~		
Power / Potenza	kW	-	1,1		
Water Lift max. / Depressione max.	mm.H ₂ O	-	2.250		
Air Flow max. / Portata d'aria max.	M ³ /h	-	215		
Filter surface / Superficie filtrante	Cm ²	12.000	20.000		
Filter type / Tipo di filtro		Star / Tasche			
Ø filter / Ø filtro	mm.	420			
Filter efficiency / Efficienza filtro	Cat (BIA)	L ANT	M ANT		
2nd stage filter / Secondo livello filtrazione		Polypropilene PPL			
3rd stage filter / Terzo livello filtrazione		3x fiber filter / 3x filtri fibra			
Oil capacity / Capacità olio	Lt.	27	8		
Dust capacity / Capacità polveri	Lt.	13	4		
Ø Suction inlet / Ø Bocchettone	mm.	50in - 80out	50		
Noise level / Rumorosità (EN ISO 3744)	dB(A)	-	78		
Dimensions / Dimensioni	cm.	50x60x112h	63x57x121h		
Weight / Peso	kg.	36	49		

Atex version price / Prezzo versioni Atex		Price / Prezzo / €	
SEP.EX-001		SEP.EX-001	€ 2.932,00
W2 XR Z22 MDI		W2Z22MDI-001	€ 4.477,00

Inert oil not included with DU-PUY products / *Olio inert non fornito con i prodotti DU-PUY*

W2 XR Z22 MDI - Options / Opzioni		Price / Prezzo / €	
Remote Control / Avviamento locale remoto		PN/SYST	+ € 576,00
Accessory basket / Cestino portaccessori		AB	+ € 83,00
H14 Absolute filter kit / Filtro assoluto Hepa H14		H14	+ € 248,00
Safety pressure valve installed on bin / Valvola di sovrappressione		PRF	Included
Stainless steel AISI 304 tank / Contenitore in acciaio inox AISI 304		X	Included
Stainless steel AISI 304 tank and filter chamber / Contenitore e camera in acciaio inox AISI 304		XX	+ € 399,00



OPTIONAL AND ACCESSORIES
OPZIONI ED ACCESSORI

	<p>SEP.DPY-0006</p>	<p>Lt 100 Wet & Dry mobile pre-separator Ø 80mm suction inlets, tilting container</p>	<p>€ 1.045,00</p>	
<p><i>Separatore carrellato 100LT per liquidi e solidi, bocchettoni Ø80mm, contenitore basculante</i></p>		<p>SEP.DPY-0005</p>	<p>Separator with polyester filter 20.000cm² CAT L Ø460 Manual filter cleaning system and detachable 60Lt. container</p>	<p>€ 1.536,00</p>
<p><i>Separatore filtrante Ø460 con filtro poliestere Cat L. 20.000cm² Scuotifiltro manuale e sgancio rapido per contenitore da 60 Lt.</i></p>		<p>SEP.DPY-0003</p>	<p>200 Lt. Tilting Wet & Dry separator with polyester filter with 90° discharge - suction inlets Ø80</p>	<p>€ 3.175,00</p>
<p><i>Benna ribaltabile Wet & Dry Lt. 200 filtrante con scarico a 90° - Bocchettoni Ø 80 mm</i></p>		<p>SEP.DPY-0007</p>	<p>Mobile pre-separator with water for very hot material</p>	<p>€ 915,00</p>
<p><i>Separatore ad acqua per sostanze incandescenti</i></p>		<p>SEP.DPY-0024</p>	<p>Lt. 100 pre-separator for metal chips with sieved grid - suction inlets in/out Ø50mm</p>	<p>€ 999,00</p>
<p><i>Separatore specifico per trucioli con griglia a setaccio lt.100 - bocchettoni in/out Ø50mm</i></p>		<p>CC.200-002</p>	<p>Lt. 200 wheeled container for oils and emulsions with booster pump</p>	<p>€ 1.850,00</p>
<p><i>Contenitore carrellato per trasporto oli ed emulsioni con pompa di rilancio Lt.200</i></p>				

SEP.DPY-0011
**Lt 120 Dry Cyclonic pre-separator
suction inlets Ø 80 mm**
€ 1.352,00

Separatore ciclonico solidi Lt. 120 - bocchettoni Ø 80 mm
SEP.DPY-0014
**Lt 200 Cyclonic pre-separator with Ø150
butterfly valve and big-bag chassis, suction
inlets Ø80mm**
€ 4.526,00

Separatore ciclonico Lt. 200 con scarico a farfalla Ø150 e telaio insaccamento Big. Bag, Bocchettoni Ø80mm
SEP.DPY-0041
**Lt. 1000 Cyclon pre-separator with
Ø250 butterfly valve and telescopic
big-bag chassis, suction inlets Ø120mm**
€ 10.990,00



Separatore ciclonico Lt. 1000 con scarico a farfalla Ø250 e telaio telescopico con insaccamento Big.Bag, bocchettone Ø120mm
SEP.DPY-0012
**Lt. 600 Cyclon pre-separator with
frontal discharge and forklift intakes -
suction inlets Ø120mm**
€ 5.454,00

Cassonetto scarico frontale Lt. 600 inforcabile - bocchettoni Ø120mm
SEP.DPY-0013
**Lt. 1000. Cyclon pre-separator with
frontal discharge and forklift intakes -
suction inlets Ø120mm**
€ 5.990,00

Cassonetto scarico frontale Lt.1000 inforcabile - bocchettoni Ø120mm
SEP.DPY-0030
Lt. 100. High efficiency cyclon pre-separator with 100lt. container
€ 2.945,00





Ciclone pre-separatore ad alta efficienza con contenitore da 100lt.



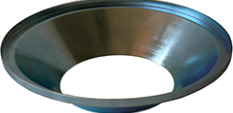

*For discharge systems and level detectors, please consult CVS section pag.135
Per sistemi di scarico e sonde di livello disponibili, consultare sezione CVS a pag.135

	Code/Codice	Ø mm	Ømm inlets	Description/Descrizione	Price/Prezzo
	TA.0110.7016	590 - 615	80	Drum adaptor separator cover <i>Separatore - adattatore per fusti</i>	€ 554,00
	KT.0427.7016	590 - 615		Drum adaptor dry filter kit <i>Kit filtro polveri per adattatori fusti</i>	€ 267,00
	TA.0149.0000	590 - 615		Drum adaptor floating kit for liquids <i>Kit galleggiante liquidi per adattatore fusti</i>	€ 348,00
	TA.0212.7016	560	80	Pre-separator drum cover with cyclone	€ 720,00
	TA.0420.7016	590	80	<i>Coperchio separatore con ciclone</i>	€ 770,00
	TA.0421.7016	615	80		€ 826,00
	CT.0004.7016	500	50	Pre-separator drum cover	€ 317,00
	CT.0005.7016	560	70	<i>Coperchio separatore</i>	€ 412,00
	CT.0006.7016	590	50		€ 382,00
	CT.0008.7016	615	70		€ 478,00







OPTIONAL / OPZIONI

	Models/Modelli	Code/Codice	Ømm	Description/Descrizione	Price/Prezzo
	WD 3000 W2	TA.0606.0000	50	Fixed Wet & Dry attachment tool for floor cleaning 700mm	€ 348,00
	WD4500	TA.0607.0000	60	Accessorio fisso Wet & Dry 700mm larghezza per pulizia pavimenti	€ 348,00
 		TA.0058.0000		Spare brush strip for floor cleaning fixed attachment Strip setole accessorio fisso Wet & Dry	€ 28,00
		SL.0051.0000		Spare squeegee floor cleaning fixed attachment Lamina in silicone, accessorio fisso per Wet&Dry	€ 21,00
	W3 W3 Infini W3 100Lt M Series	SL.3024.0020	460	Cyclone for filter protection (Dry applications) Ciclone protezione filtro (applicazioni polveri)	€ 152,00
	W2	TA.0240.0000	420	Pressure differential kit for use of disposable bags	€ 174,00
	W3 - W3 Infini	TA.0658.0000	460	Kit griglia depressore per aspirazione in sacchi a perdere	€ 174,00
	W3 100Lt - M Series	TA.0217.0000			€ 174,00
	MHD	TA.0327.0000			€ 220,00
	WD1500 W2 W3 W3 Infini M Series	SL.0045.0200	400	Steel ring for suction into disposable bags Anello fermasacco per aspirazione in sacchi a perdere	€ 81,00
	W1	SL.6627.0200			€ 73,50

	Models/Modelli	Code/Codice	Ømm	Description/Descrizione	Price/Prezzo
	PROVAC 150	TA.1247.0000	150	Single use bag TNT microfiber <i>Sacchetto monouso TNT microfibra</i>	€ 6,75
	W1	TA.1216.0000	280	Ant. Disposable single use bag dust class H, 80µ	€ 1,95
	W3 W3 Infini M Series	TA.0501.0000	460	Sacchetto monouso ant. polvere classe H, 80µ	€ 2,90
	MHD Series	TA.0568.0000	560		€ 3,50
		TA.0245.0000		Endless BAG - Roll Spare bags (4 x 22m Rolls per box) <i>Scatola di rotoli ricambio (Confezione da 4 rotoli x 22m)</i>	€ 110,00
		TA.0677.0000		Endless BAG - Antistatic Roll Spare bags (4 x 22m Rolls per box) <i>Scatola di rotoli antistatici ricambio (Confezione da 4 rotoli x 22m)</i>	€ 130,00
	W3 Infini M Series	TA.0611.0000	460	Lifting bracket and ring for 100lt. container <i>Staffa e anello per sollevamento e ribaltamento contenitore lt.100</i>	€ 654,00
	MHD Series	TA.0753.3000	560	Lifting bracket and ring for 160lt. container <i>Staffa e anello per sollevamento e ribaltamento contenitore lt.160</i>	€ 790,00

ACCESSORY KIT / KIT ACCESSORI

For Wet&Dry/Per Polveri&Liquidi	Code/Codice	Ømm	Description/Descrizione	Price/Prezzo
D 800 - WD 1000 - W1 	TA.1156.0000	32	ACCESSORY KIT Ø32 WET&DRY / KIT ACCESSORI Ø32 POLVERI	€ 145,00
	Composed by:			
	SL.3061.0000		1 58/32 Hose cuff PVC / Manicotto PVC	
	TA.1163.0000		3m PVC hose / Tubo PVC Ø32	
	SL.5938.0000		PVC bend with flow regulator / Curva in PVC con regolatore di portata Ø36	
	SL.5939.0000		2 Steel Extension / Prolunga acciaio	
	SL.5940.0000		1 Lance PVC / Lancia piatta PVC	
	SL.5941.0000		1 Wheeled brush / Spazzola pavimento con ruote	
	SL.5942.0000		1 Wheeled squeegee / Spazzola ventosa con ruote	
SL.5943.0000		1 PVC brush / Pennello PVC		
SL.5944.0000		1 PVC triangle nozzle / Bocchetta triangolare PVC		
WD 1500 - WD 1500C 	TA.0614.0000	40	ACCESSORY KIT Ø38 WET&DRY / KIT ACCESSORI Ø38 POLVERI E LIQUIDI	€ 150,00
	Composed by:			
	SL.0008.0000		1 Hose cuff PVC / Manicotto PVC	
	SL.3032.0000		1 58/40 Hose cuff PVC / Manicotto PVC	
	TA.0002.0000		3m PVC hose / Tubo PVC	
	TA.0157.0000		1 Double bend / Doppia curva	
	TA.0159.0000		1 PVC floor brush dry / Spazzola pavimenti polveri	
	TA.0158.0000		1 PVC floor squeegee W&D/Ventosa pavimenti liquidi	
	SL.3072.0000		1 Lance PVC / Lancia piatta PVC	
SL.0162.0000		1 PVC brush / Pennello PVC		
WD 3000/AIR - W2/AIR 	TA.0615.0000	40	ACCESSORY KIT Ø40 WET&DRY / KIT ACCESSORI Ø40 POLVERI E LIQUIDI	€ 203,00
	Composed by:			
	SL.0008.0000		1 Hose cuff PVC / Manicotto PVC	
	SL.0117.0000		1 50/40 Hose cuff PVC / Manicotto PVC	
	TA.0002.0000		3m PVC hose / Tubo PVC	
	SL.2937.0000		1 50/50 Inlet / Innesto girevole 50/50	
	SL.0212.7016		1 Double bend / Doppia curva	
	SL.0172.0000		1 500mm Aluminium lance / Lancia alluminio	
	TA.0440.0000		1 Wheeled squeegee / Spazzola ventosa con ruote	
SL.0162.0000		1 PVC brush / Pennello PVC		
WD 3000/AIR - W2/AIR 	TA.0616.0000	40	ACCESSORY KIT Ø40 DRY / KIT ACCESSORI Ø40 POLVERI	€ 203,00
	Composed by:			
	SL.0008.0000		1 Hose cuff PVC / Manicotto PVC	
	SL.0117.0000		1 50/40 Hose cuff PVC / Manicotto PVC	
	TA.0002.0000		3m PVC hose / Tubo PVC	
	SL.2937.0000		1 50/50 Inlet / Innesto girevole	
	SL.0212.7016		1 Double bend / Doppia curva	
	SL.0172.0000		1 500mm Aluminium lance / Lancia alluminio	
	TA.0438.0000		1 Wheeled brush / Spazzola pavimento con ruote	
SL.0162.0000		1 PVC brush / Pennello PVC		
WD 4500 - W3/AIR - M Series 	TA.0617.0000	50	ACCESSORY KIT Ø50 WET&DRY / KIT ACCESSORI Ø50 POLVERI E LIQUIDI	€ 309,00
	Composed by:			
	SL.0014.0000		2 Rubber Hose cuffs / Manicotti gomma	
	TA.0003.0000		3m PVC hose / Tubo PVC	
	SL.0158.0020		1 80/50 Reduction / Innesto girevole	
	SL.0137.0000		1 PVC brush / Pennello PVC	
	SL.0170.7016		1 Double bend / Doppia curva	
	TA.0023.0000		1 Flat nozzle 500mm / Bocchetta piatta	
	TA.0132.0000		1 Wheeled squeegee / Spazzola ventosa con ruote	

For Wet&Dry / Per Polveri&Liquidi
WD 4500 - W3/AIR - M Series

Code/Codice	Ømm	Description/Descrizione	Price/Prezzo
TA.0618.0000	50	ACCESSORY KIT Ø50 DRY / KIT ACCESSORI Ø50 POLVERI	€ 309,00
Composed by:			
SL.0014.0000		2 Rubber Hose cuffs / Manicotti gomma	
TA.0003.0000		3m PVC hose / Tubo PVC	
SL.0158.0020		1 80/50 Reduction / Innesto girevole	
SL.0137.0000		1 PVC brush / Pennello PVC	
SL.0170.7016		1 Double bend / Doppia curva	
TA.0023.0000		1500mm Flat nozzle / Bocchetta piatta	
TA.0141.0000		1 Wheeled floor brush / Spazzola pavimento con ruote	

WD 4500 - W3 - M Series

Code/Codice	Ømm	Description/Descrizione	Price/Prezzo
TA.0619.0000	70	ACCESSORY KIT Ø70 WET&DRY / KIT ACCESSORI Ø70 POLVERI E LIQUIDI	€ 523,00
Composed by:			
SL.0003.0000		2 Rubber Hose cuffs / Manicotti gomma	
TA.0075.0000		3m PU antistatic hose / Tubo PU antistatico	
SL.0180.0020		1 80/70 Reduction / Riduzione	
SL.0171.7016		1 Double bend / Doppia curva	
TA.0018.0000		1500mm Flat nozzle / Bocchetta piatta	
TA.0136.0000		1 Wheeled squeegee / Spazzola ventosa con ruote	
TA.0147.0000		1 Rubber cone nozzle / Tronco conico gomma	

Overhead cleaning kit / Kit pulizie in altezza

Code/Codice	Ømm	Description/Descrizione	Price/Prezzo
TA.0951.0000	40	OVERHEAD CLEANING ACCESSORY KIT Ø40 KIT ACCESSORI PULIZIE IN ALTEZZA Ø40	€ 431,00
Composed by:			
TA.0560.0000		150/40 Vacuum rubber reduction / Riduzione gomma	
TA.0671.0000		1 Hose straight connection / Raccordo dritto flex	
TA.0668.0000		3 x 1m Aluminium extensions / Prolunghe alluminio	
TA.0669.0000		190° Steel bend curved connection / Raccordo curvo	
TA.0670.0000		1 Accessory straight connection / Raccordo dritto	
SL.1332.0000		1 Rounded brush / Spazzola rotonda	
TA.0774.0000		1 Antistatic wall brush / Spazzola parete antistatica	













Code/Codice	Ømm	Description/Descrizione	Price/Prezzo
TA.0952.0000	50	OVERHEAD CLEANING ACCESSORY KIT Ø50 KIT ACCESSORI PULIZIE IN ALTEZZA Ø50	€ 443,00
Composed by:			
TA.0682.0000		1 Ø50 Hose connector / Connessione tubo	
TA.0679.0000		3 x 1m Aluminium extensions / Prolunghe alluminio	
TA.0680.0000		190° Steel bend curved connection / Raccordo curvo	
TA.0681.0000		1 Accessory straight connection / Raccordo dritto	
SL.1332.0000		1 Rounded brush / Spazzola rotonda	
TA.0773.0000		1 Antistatic wall brush / Spazzola parete antistatica	

For Oil&Chips / Per Olio&Trucioli
W 3 - M Series - Chipvac 400





Code/Codice	Ømm	Description/Descrizione	Price/Prezzo
TA.1225.0000	50	ACCESSORY KIT OIL&CHIPS Ø50 / KIT ACCESSORI OLIO E TRUCIOLI Ø50	€ 272,00
Composed by:			
SL.0015.0000		1 Rubber ant Hose cuffs / Manicotto gomma ant	
TA.0042.0000		3m reinforced abrasion proof PU hose / Tubo PU antiabrasivo rinforzato	
SL.0026.0020		1 Steel bend connection / Raccordo curvo acciaio	
SL.0158.0020		1 80/50 Reduction / Riduzione	
SL.0225.0000		1 Hose clamp / Fascetta stringitubo	
TA.0020.0000		1500mm Aluminium lance / Lancia alluminio	
TA.0014.0000		1 Rubber cone nozzle / Tronco conico gomma	

ACCESSORY KIT / KIT ACCESSORI

For Oil&Chips / Per Olio&Trucioli	Code/Codice	Ømm	Description/Descrizione	Price/Prezzo
CHIPVAC 200 	TA.0620.0000	50	ACCESSORY KIT OIL&CHIPS Ø50 / KIT ACCESSORI OLIO E TRUCIOLI Ø50	€ 272,00
	Composed by:			
	SL.0015.0000		1 Rubber ant Hose cuffs / Manicotto gomma ant	
	TA.0042.0000		3m reinforced abrasion proof PU hose / Tubo PU antiabrasivo rinforzato	
	SL.0026.0020		1 Steel bend connection / Raccordo curvo acciaio	
	SL.2918.0000		1 90/50 Reduction / Riduzione	
	SL.0225.0000		1 Hose clamp / Fascetta stringitubo	
TA.0020.0000		1 500mm Aluminium lance / Lancia alluminio		
TA.0014.0000		1 Rubber cone nozzle / Tronco conico gomma		
OILVAC 130 - OILVAC 130P 	TA.0837.0000	50	ACCESSORY KIT OIL&CHIPS Ø50 / KIT ACCESSORI OLIO E TRUCIOLI Ø50	€ 288,00
	Composed by:			
	SL.0015.0000		1 Rubber ant Hose cuffs / Manicotto gomma ant	
	TA.0042.0000		3m reinforced abrasion proof PU hose / Tubo PU antiabrasivo rinforzato	
	SL.0026.0020		1 Steel bend connection / Raccordo curvo acciaio	
	CV.0042.0000		1 50/50 Connection / Innesto	
	SL.0225.0000		1 Hose clamp / Fascetta stringitubo	
TA.0020.0000		1 500mm Aluminium lance / Lancia alluminio		
TA.0014.0000		1 Rubber cone nozzle / Tronco conico gomma		
OILVAC 100 - OILVAC 100P OILVAC 200 - OILVAC 200T 	TA.0621.0000	50	ACCESSORY KIT OIL&CHIPS Ø50 / KIT ACCESSORI OLIO E TRUCIOLI Ø50	€ 318,00
	Composed by:			
	SL.0015.0000		1 Rubber ant Hose cuffs / Manicotto gomma ant	
	TA.0042.0000		3m reinforced abrasion proof PU hose / Tubo PU antiabrasivo rinforzato	
	SL.0026.0020		1 Steel bend connection / Raccordo curvo acciaio	
	SL.0225.0000		1 Hose clamp / Fascetta stringitubo	
	TA.0020.0000		1 500mm Aluminium lance / Lancia alluminio	
TA.0014.0000		1 Rubber cone nozzle / Tronco conico gomma		
OILVAC 300 - 450 - 600HV 	TA.0887.0000	50	ACCESSORY KIT OIL&CHIPS Ø50 / KIT ACCESSORI OLIO E TRUCIOLI Ø50	€ 403,00
	Composed by:			
	SL.0015.0000		1 Rubber ant Hose cuffs / Manicotto gomma ant	
	TA.0042.0000		3m reinforced abrasion proof PU hose / Tubo PU antiabrasivo rinforzato	
	SL.0026.0020		1 Steel bend connection / Raccordo curvo acciaio	
	SL.0225.0000		1 Hose clamp / Fascetta stringitubo	
	TA.0020.0000		1 500mm Aluminium lance / Lancia alluminio	
SL.0140.7016		1 Ø50 Scraping nozzle / Ventosa raschiante		
TA.0014.0000		1 Rubber cone nozzle / Tronco conico gomma		
M Series - Chipvac 400 	TA.0622.0000	70	ACCESSORY KIT OIL&CHIPS Ø70 / KIT ACCESSORI OLIO E TRUCIOLI Ø70	€ 435,00
	Composed by:			
	TA.0077.0000		3m PU hose with cuff / Tubo PU con manico	
	SL.2987.0000		1 80/70 Reduction / Riduzione	
	TA.0018.0000		1 500mm Flat nozzle / Bocchetta piatta	
	SL.0121.0020		1 500mm Scraping nozzle / Ventosa raschiante	
	TA.0147.0000		1 Rubber cone nozzle / Tronco conico gomma	

Antistatic kit / Kit antistatici	Code/Codice	Ømm	Description/Descrizione	Price/Prezzo
W 2 - W 2 Infini - W2 XR Z22 	TA.0230.0000 Composed by: SL.0013.0000 SL.0117.0000 SL.1218.0020 TA.0204.0000 TA.0163.0000 SL.0212.7016 TA.0438.0011	40	ANTISTATIC DRY ACCESSORY KIT Ø40 / KIT ACCESSORI ANTISTATICI POLVERI Ø40 1 Antistatic hose cuff / Manicotto antistatico 150/40 Antistatic hose cuff / Manicotto antistatico 150/50 Connection / Innesto 3m antistatic hose / Tubo antistatico 1 Rubber cone nozzle / Tronco conico gomma 1 Double bend / Doppia curva 1 Stainless steel wheeled brush / Spazzola pavimento in acciaio inox	€ 238,00
W 2 - W 2 Infini - W2 XR Z22 	TA.0371.0000 Composed by: SL.0013.0000 SL.0117.0000 SL.1218.0020 TA.0204.0000 TA.0163.0000 SL.0212.7016 TA.0440.0011	40	ANTISTATIC WET&DRY ACCESSORY KIT Ø40 KIT ACCESSORI ANT. POLVERI E LIQUIDI Ø40 1 Antistatic hose cuff / Manicotto antistatico 150/40 Antistatic hose cuff / Manicotto antistatico 150/50 Connection / Innesto 3m antistatic hose / Tubo antistatico 1 Rubber cone nozzle / Tronco conico gomma 1 Double bend / Doppia curva 1 Stainless steel wheeled squeegee / Ventosa pavimento con ruote in acciaio inox	€ 238,00
W 3 - W 3 Infini - M Series 	TA.0623.0000 Composed by: SL.0013.0000 SL.0117.0000 SL.0158.0020 TA.0204.0000 TA.0163.0000 SL.0212.7016 TA.0438.0011	40	ANTISTATIC DRY ACCESSORY KIT Ø40 / KIT ACCESSORI ANTISTATICI POLVERI Ø40 1 Antistatic hose cuff / Manicotto antistatico 150/40 Antistatic hose cuff / Manicotto antistatico 180/50 Reduction / Riduzione 3m antistatic hose / Tubo antistatico 1 Rubber cone nozzle / Tronco conico gomma 1 Double bend / Doppia curva 1 Stainless steel wheeled brush / Spazzola pavimento in acciaio inox	€ 270,00
W 3 - W 3 Infini - M Series 	TA.0624.0000 Composed by: SL.0013.0000 SL.0117.0000 SL.0158.0020 TA.0204.0000 TA.0163.0000 SL.0212.7016 TA.0440.0011	40	ANTISTATIC WET&DRY ACCESSORY KIT Ø40 / KIT ACCESSORI ANTISTATICI POLVE- RI&LIQUIDI Ø40 1 Antistatic hose cuff / Manicotto antistatico 150/40 Antistatic hose cuff / Manicotto antistatico 180/50 Reduction / Riduzione 3m antistatic hose / Tubo antistatico 1 Rubber cone nozzle / Tronco conico gomma 1 Double bend / Doppia curva 1 Stainless steel wheeled squeegee / Ventosa a pavimento con ruote in acciaio inox	€ 270,00
W 3 - W 3 Infini - M Series 	TA.0625.0000 Composed by: SL.0017.0000 SL.0158.0020 TA.0205.0000 TA.0014.0000 SL.0170.7016 TA.0141.0011	50	ANTISTATIC DRY ACCESSORY KIT Ø50 / KIT ACCESSORI ANTISTATICI POLVERI Ø50 2 Antistatic hose cuffs / Manicotti antistatici 180/50 Reduction / Riduzione 3m antistatic hose / Tubo antistatico 1 Rubber cone nozzle / Tronco conico gomma 1 Double bend / Doppia curva 1 Stainless steel wheeled brush / Spazzola pavimento in acciaio inox	€ 335,00

ACCESSORY KIT / KIT ACCESSORI

Antistatic kit / Kit antistatici	Code/Codice	Ømm	Description/Descrizione	Price/Prezzo
W 3 - W 3 Infini - M Series 	TA.0626.0000	50	ANTISTATIC WET&DRY ACCESSORY KIT Ø50/ <i>KIT ACCESS. ANTISTATICI POLVERI&LIQUIDIØ50</i> Composed by: SL.0017.0000 2 Antistatic hose cuffs / <i>Manicotti antistatici</i> SL.0158.0020 1 80/50 Reduction / <i>Riduzione</i> TA.0205.0000 3m antistatic hose / <i>Tubo antistatico</i> TA.0014.0000 1 Rubber cone nozzle/ <i>Tronco conico gomma</i> SL.0170.7016 1 Double bend / <i>Doppia curva</i> TA.0132.0011 1 Stainless steel wheeled squeegee / <i>Ventosa a pavimento con ruote in acciaio inox</i>	€ 335,00
W 3 - W 3 Infini - M Series 	TA.0627.0000	70	ANTISTATIC DRY ACCESSORY KIT Ø70 / <i>KIT ACCESSORI ANTISTATICI POLVERI Ø70</i> Composed by: SL.0003.0000 2 Antistatic hose cuffs / <i>Manicotti antistatici</i> SL.0180.0020 1 80/70 Reduction / <i>Riduzione</i> TA.0075.0000 3m PU antistatic hose / <i>Tubo antistatico PU</i> SL.0122.0000 1 Rubber cone nozzle / <i>Tronco conico gomma</i> SL.0171.7021 1 Double bend / <i>Doppia curva</i> TA.0143.0011 1 Stainless steel wheeled brush / <i>Spazzola pavimento in acciaio inox</i>	€ 436,00
Stainless steel antistatic kit / Kit antistatici inox	Code/Codice	Ømm	Description/Descrizione	Price/Prezzo
W2 - W2 Infini - W 2 XR Z22 	TA.0643.0000	40	ANTISTATIC STAINLESS STEEL WET&DRY <i>ACCESSORY KIT Ø40 / KIT ACCESSORI INOX ANTISTATICI WET&DRY Ø40</i> Composed by: TA.0204.0000 3m antistatic hose / <i>Tubo antistatico</i> SL.0013.0000 1 Antistatic hose cuff / <i>Manicotto antistatico</i> SL.1218.0011 150/40 Antistatic hose cuff / <i>Manicotto antistatico</i> SL.2937.0000 150/50 Stainless steel reduction / <i>Riduzione inox</i> TA.0225.0000 1 Stainless steel double bend / <i>Doppia curva inox</i> TA.0323.0000 1 Wheeled stainless steel squeegee / <i>Ventosa pavimento in acciaio inox</i>	€ 305,00
W3 - W3 Infini - M Series 	TA.0628.0000	50	ANTISTATIC STAINLESS STEEL WET&DRY <i>ACCESSORY KIT Ø50 / KIT ACCESSORI INOX ANTISTATICI WET&DRY Ø50</i> Composed by: SL.0017.0000 2 Antistatic hose cuffs / <i>Manicotti antistatici</i> SL.0158.0010 1 80/50 Stainless steel reduction / <i>Riduzione inox</i> TA.0205.0000 3m antistatic hose / <i>Tubo antistatico</i> TA.0016.0000 1 Rubber cone nozzle with stainless steel connection/ <i>Tronco conico gomma con raccordo in inox</i> SL.0170.0011 1 Double bend / <i>Doppia curva</i> TA.0133.0000 1 Wheeled stainless steel squeegee / <i>Ventosa pavimento in inox</i>	€ 453,00

Oven cleaning kit / Kit Pulizia forni	Code/Codice	Ømm	Description/Descrizione	Price/Prezzo
WD 3000 - W2 - W2 Infini - W2 XR Z22  	TA.1048.0000	40	OVEN CLEANING ACCESSORY KIT Ø40 / <i>KIT ACCESSORI PULIZA FORNI Ø40</i>	€ 282,00
	Composed by: TA.1043.0000		1 Oven wheeled squeegee with connection / <i>Ventosa mobile forni MM420 Ø40 con raccordo 50/40</i>	
	TA.1044.0000		2,5 m Stainless steel with hose cuff 50>40 / <i>Tubo in acciaio inox manicottato 50>40</i>	
	TA.1045.0000		1m Oven extension with protection / <i>Prolunga forni</i>	
	TA.1046.0000		1m Oven extension with partial protection / <i>Prolunga forni con protezione parziale</i>	
	TA.1047.0000		1m Oven extension without protection / <i>Prolunga forni senza protezione</i>	
W 3 - W 3 Infini - M Series  	TA.1050.0000	40	OVEN CLEANING ACCESSORY KIT Ø40 / <i>KIT ACCESSORI PULIZA FORNI Ø40</i>	€ 282,00
	Composed by: TA.1043.0000		1 Oven wheeled squeegee with connection / <i>Ventosa mobile forni MM420 Ø40 con raccordo 50/40</i>	
	TA.1049.0000		2,5 m Stainless steel with hose cuff 80>40 / <i>Tubo in acciaio inox manicottato 80>40</i>	
	TA.1045.0000		1m Oven extension with protection / <i>Prolunga forni</i>	
	TA.1046.0000		1m Oven extension with partial protection / <i>Prolunga forni con protezione parziale</i>	
	TA.1047.0000		1m Oven extension without protection / <i>Prolunga forni senza protezione</i>	
W 3 - W 3 Infini - M Series  	TA.1186.0000	40	OVEN CLEANING ACCESSORY KIT Ø40 / <i>KIT ACCESSORI PULIZA FORNI Ø40</i>	€ 330,00
	Composed by: TA.1177.0000		1 Oven aluminium wheeled squeegee / <i>Ventosa mobile forni in alluminio MM430</i>	
	TA.1049.0000		2,5 m Stainless steel with hose cuff 80>40 / <i>Tubo in acciaio inox manicottato 80>40</i>	
	TA.1045.0000		1m Oven extension with protection / <i>Prolunga forni</i>	
	TA.1046.0000		1m Oven extension with partial protection / <i>Prolunga forni con protezione parziale</i>	
	TA.1047.0000		1m Oven extension without protection / <i>Prolunga forni senza protezione</i>	
Food&Pharma kit / Kit per Alimentare&Farma  	TA.0631.0000	50	FOOD & PHARMA STAINLESS STEEL AC- CESSORY KIT Ø50 / <i>KIT ACCESSORI INOX PER ALIMENTARE E FARMACEUTICA Ø50</i>	€ 470,00
	Composed by: SL.0017.0000		2 Antistatic hose cuffs / <i>Manicotti antistatici</i>	
	SL.0158.0011		1 80/50 Stainless steel reduction / <i>Riduzione inox</i>	
	TA.0205.0000		3m antistatic hose / <i>Tubo antistatico</i>	
	TA.0015.0000		1 Silicone cone nozzle with stainless steel connection / <i>Tronco conico in silicone con innesto inox</i>	
	SL.0170.0011		1 Stainless steel double bend / <i>Doppia curva inox</i>	
	TA.0142.0000		1 Wheeled stainless steel brush / <i>Spazzola pavimento inox</i>	

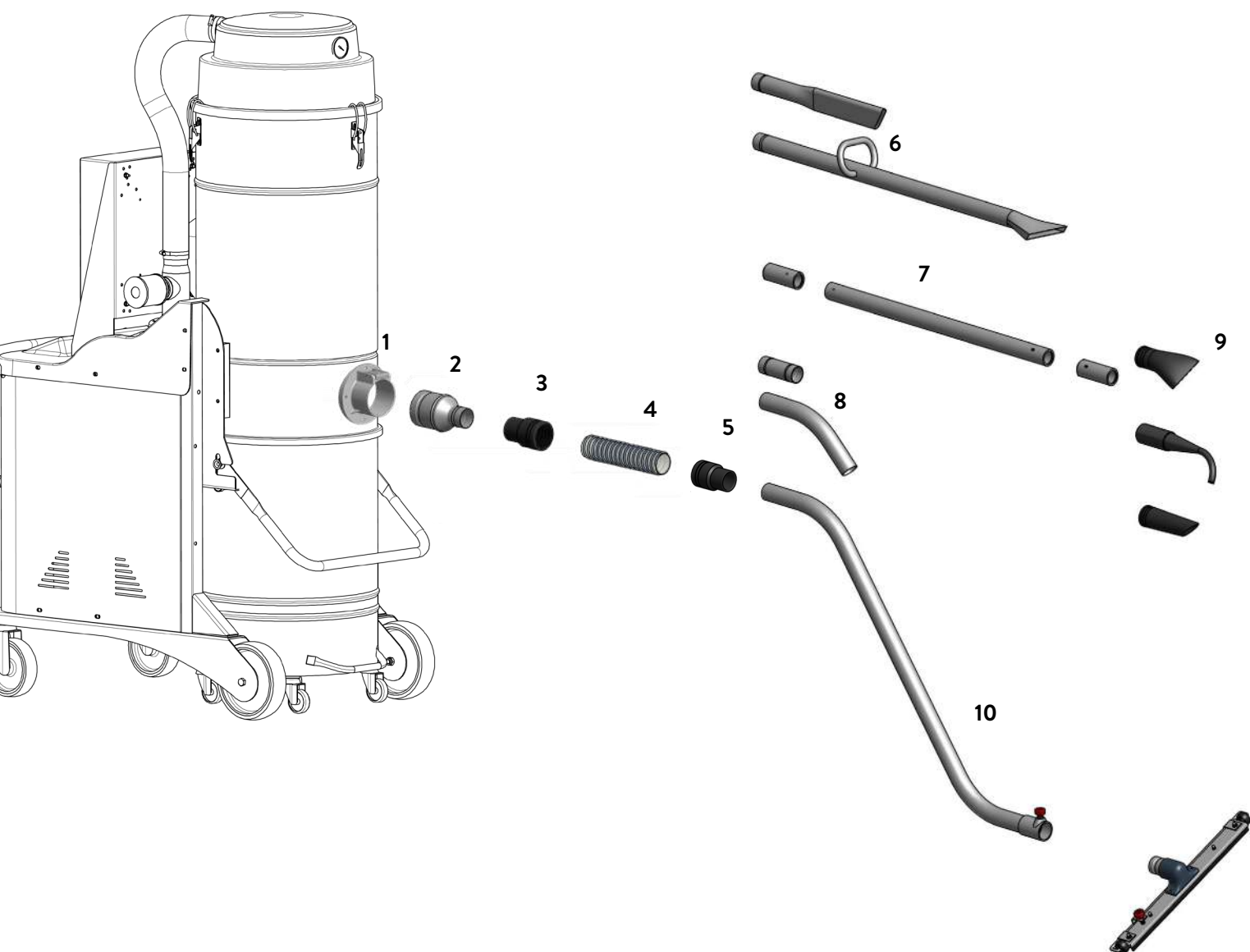

1. Suction inlet
1. Bocchettone
Ø 40 mm
Ø 50 mm
Ø 80 mm
Ø 100 mm
Ø 120 mm

2. Connection
2. Riduzione

3. Inlet hose cuff
3. Manicotto bocchettone

4. Hose
4. Tubo

5. Outlet hose cuff
5. Manicotto attacco accessorio

6. Accessories
6. Accessori

7. Extension
7. Prolunghe



8. Connections
8. Raccordi

9. Brushes and nozzles
9. Spazzole e terminali

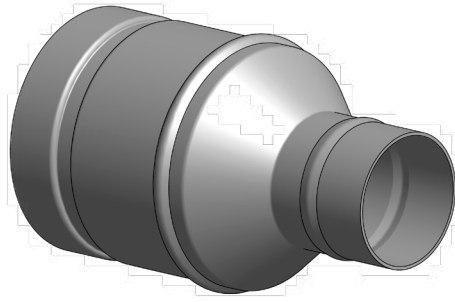
10. Double bend and brushes
10. Doppia curva ed accessori



	Code/Codice	Ømm	Description/Descrizione	Price/Prezzo
Ø40 - Ø50 CONNECTIONS/RIDUZIONI				
WD 3000 - W2 - W2 XR Z22				
	SL.3026.0000	50/40	Steel hose connector	€ 21,00
	SL.2937.0000	50/50	Innesto tubo flessibile	€ 15,00
	SL.1218.0011	50/50	Stainless Steel hose connector <i>Innesto tubo flessibile Acciaio Inox</i>	€ 31,00
	TA.0333.0000	50/50	Steel hose connector with flow regulator <i>Innesto/tubo flessibile con regolatore di portata</i>	€ 110,00
	SL.3027.0000	50/50/50	Biforcazione a 2 vie / 2 ways branch	€ 90,00
	SL.0207.0020	50/40/40	Biforcazione a 2 vie / 2 ways branch	€ 90,00
Ø80 CONNECTIONS/RIDUZIONI				
W 4500 - W3 - W3Infini - M Series - Chipvac Silovac - Oilvac 130				
	SL.0157.0020	80/40	Steel hose connection / <i>Riduzione ferro</i>	€ 38,00
	SL.0158.0020	80/50		€ 38,00
	SL.0180.0020	80/70	Steel hose connection / <i>Riduzione ferro</i>	€ 43,00
	SL.2005.0020	80/76		€ 69,00
	SL.0160.0000	80/80	Steel hose connection / <i>Riduzione ferro</i>	€ 49,00
	SL.0158.0011	80/50	Stainless Steel hose connection	€ 92,00
	SL.0180.0011	80/70	<i>Riduzione acciaio inox</i>	€ 106,00
	SL.0030.0020	80/40/40	Biforcazione a 2 vie	€ 105,00
	SL.0029.0020	80/50/50	2 ways branch	€ 105,00
	SL.0115.0020	80/70/70		€ 120,90
	SL.0175.0020	80/40/40/40	Biforcazione a 3 vie	€ 140,00
	SL.0133.0000	80/50/50/50	3 ways branch	€ 140,00

	Code/Codice	Ømm	Description/Descrizione	Price/Prezzo
Ø120 CONNECTIONS/RIDUZIONI MHD Series 	TA.0414.0000	120/70	Steel hose connection / <i>Riduzione ferro</i>	€ 120,00
	TA.0415.0000	120/80	Steel hose connection / <i>Riduzione ferro</i>	€ 120,00
	TA.0413.0000	120/100	Steel hose connection / <i>Riduzione ferro</i>	€ 120,00
	TA.0412.0000	120/120	Steel hose connection / <i>Riduzione ferro</i>	€ 130,00
	TA.0422.0000	120/70/70	<i>Biforcazione a 2 vie / 2 ways branch</i>	€ 210,00
	TA.0423.0000	120/80/80	<i>Biforcazione a 2 vie / 2 ways branch</i>	€ 210,00
	TA.0424.0000	120/100/100	<i>Biforcazione a 2 vie / 2 ways branch</i>	€ 210,00
Oilvac 130 / 130P 	CV.0042.0000	50/50	Flexible hose connection <i>Innesto tubo flessibile</i>	€ 50,00



Code/Codice Ømm Description/Descrizione Price/Prezzo

**Ø150 FLANGED IRON REDUCTION
RACCORDO IN FERRO FLANGIATO**

SL.0088.0020	100/100	Flanged iron reduction <i>Raccorto in ferro con flangia</i>	€ 95,00
SL.2635.0020	150/100	Flanged iron reduction <i>Raccorto in ferro con flangia</i>	€ 110,00
SL.2639.0020	150/120	Flanged iron reduction <i>Raccorto in ferro con flangia</i>	€ 110,00
SL.2607.0020	150/150	Flanged iron reduction <i>Raccorto in ferro con flangia</i>	€ 110,00
SL.2932.0020	150/70/70	Flanged iron 2ways branches <i>Biforcazione in ferro con flangia</i>	€ 195,00
SL.2683.0020	150/80/80	Flanged iron 2ways branches <i>Biforcazione in ferro con flangia</i>	€ 195,00
SL.2608.0020	150/100/100	Flanged iron 2ways branches <i>Biforcazione in ferro con flangia</i>	€ 195,00

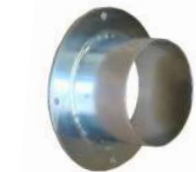
**Ø200 FLANGED IRON REDUCTION
RACCORDO IN FERRO FLANGIATO**

SL.2632.0020	200/200	Flanged iron reduction <i>Raccorto in ferro con flangia</i>	€ 125,00
--------------	---------	--	----------

**HOSE 2 WAYS BRANCHES
BIFORCAZIONI LISCE PER TUBO**

SL.0050.0020	50/50/50	Hose 2 ways branches <i>Biforcazione per tubo</i>	€ 110,00
SL.0049.0020	60/40/40	Hose 2 ways branches <i>Biforcazione per tubo</i>	€ 110,00
SL.0048.0020	60/50/50	Hose 2 ways branches <i>Biforcazione per tubo</i>	€ 110,00
SL.0110.0020	100/50/50	Hose 2 ways branches <i>Biforcazione per tubo</i>	€ 150,00
SL.0111.0020	100/60/60	Hose 2 ways branches <i>Biforcazione per tubo</i>	€ 150,00
SL.0112.0020	100/80/80	Hose 2 ways branches <i>Biforcazione per tubo</i>	€ 150,00



	Code/Codice	Ø in mm	Ø out mm	Description/Descrizione	Coil length	Price
EVAFLEX HOSE/TUBO EVAFLEX PVC						
Corrugated hose for general cleaning tasks / <i>Tubo corrugato per lavori di pulizia generale</i>						
	TA.0716.0000	40		Hose and hose cuffs included <i>Completo di tubo e manicotti</i>	3	€ 36,00
	TA.0008.0000	50	40		3	€ 47,00
	TA.0717.0000	50	40		5	€ 65,00
	TA.0718.0000	50	40		10	€ 110,00
	TA.0009.0000	50		Hose and hose cuffs included <i>Completo di tubo e manicotti</i>	3	€ 91,00
	TA.0728.0000	50			5	€ 121,00
	TA.0729.0000	50			10	€ 196,00
	*TA.0755.0000	40		Not fractionable, without hose cuffs <i>Non frazionabile, manicotti non inclusi</i>	30	€ 270,00
	*TA.0759.0000	50			30	€ 450,00
	EVAFLEX ANTISTATIC HOSE/TUBO EVAFLEX CONDUTTIVO					
Antistatic corrugated hose for suction of conductive materials / <i>Tubo corrugato antistatico per aspirazione di materiali conduttori</i>						
	TA.0719.0000	40		Hose and hose cuffs included <i>Completo di tubo e manicotti</i>	3	€ 78,50
	TA.0409.0000	50	40		3	€ 80,50
	TA.0720.0000	50	40		5	€ 113,50
	TA.0721.0000	50	40		10	€ 196,00
	TA.0410.0000	50		Hose and hose cuffs included <i>Completo di tubo e manicotti</i>	3	€ 116,00
	TA.0730.0000	50			5	€ 103,00
	TA.0731.0000	50			10	€ 279,00
	*TA.0756.0000	40		Not fractionable, without hose cuffs <i>Non frazionabile, manicotti non inclusi</i>	30	€ 447,00
	*TA.0760.0000	50			30	€ 624,00



ADDITIONAL DISCOUNT FOR MINIMUM CUMULATIVE ORDER OF COILS LISTED ABOVE: 1 coil / rotolo +10%

SCONTO QUANTITA' PER L'ACQUISTO MINIMO CUMULATIVO DI ROTOLI COMPLETI: 3 coils / rotoli +15%

5 coils / rotoli +20%

FLEXIBLE HOSES / TUBI FLESSIBILI

Code/Codice Ø in mm Ø out mm Description/Descrizione Coil length Price

SUPERFLEX POLYURETHANE ANTISTATIC HOSE / TUBO SUPERFLEX POLIURETANO ANTISTATICO

Food grade certificate hose with PVC spiral and copper wire for suction of conductive materials.

Tubo certificato per uso alimentare con spirale in PVC e treccia in rame per aspirazione di materiali conduttivi.



TA.0725.0000	40		Hose and hose cuffs included <i>Completo di tubo e manicotti</i>	3	€ 95,00
TA.0068.0000	50	40		3	€ 90,00
TA.0726.0000	50	40		5	€ 127,00
TA.0727.0000	50	40		10	€ 217,00
TA.0069.0000	50		Hose and hose cuffs included <i>Completo di tubo e manicotti</i>	3	€ 118,00
TA.0735.0000	50			5	€ 165,00
TA.0736.0000	50			10	€ 285,00
TA.0106.0000	70		Hose and hose cuffs included <i>Completo di tubo e manicotti</i>	3	€ 189,00
TA.0744.0000	70			5	€ 267,00
TA.0745.0000	70			10	€ 462,00
*TA.0758.0000	40		Not fractionable, without hose cuffs <i>Non frazionabile, manicotti non inclusi</i>	20	€ 446,00
*TA.0762.0000	50			20	€ 510,00
*TA.0764.0000	70			20	€ 570,00

*ADDITIONAL DISCOUNT FOR MINIMUM CUMULATIVE ORDER OF COILS LISTED ABOVE: 1 coil / rotolo +10%

*SCONTO QUANTITA' PER L'ACQUISTO MINIMO CUMULATIVO DI ROTOLI COMPLETI: 3 coils / rotoli +15%

5 coils / rotoli +20%

Code/Codice Ø in mm Ø out mm Description/Descrizione Coil length Price €/mt

May be ordered in 2,5/5/10mt or complete coil only <i>Ordinabile in tagli da 2,5/5/10mt o rotolo intero</i>	**TA.0081.0000	100	Without hose cuffs <i>Senza manicotti</i>	20	€ 63,40/ mt
May be ordered in 2,5/5/10mt or complete coil only <i>Ordinabile in tagli da 2,5/5/10mt o rotolo intero</i>	**TA.0219.0000	120	Without hose cuffs <i>Senza manicotti</i>	20	€ 74,00/ mt
May be ordered in 2,5/5/10mt or complete coil only <i>Ordinabile in tagli da 2,5/5/10mt o rotolo intero</i>	**TA.0455.0000	150	Without hose cuffs <i>Senza manicotti</i>	10	€ 94,00/ mt

**ADDITIONAL DISCOUNT FOR MINIMUM CUMULATIVE ORDER OF COILS LISTED ABOVE: 1 coil / rotolo +10%

**SCONTO QUANTITA' PER L'ACQUISTO MINIMO CUMULATIVO DI ROTOLI COMPLETI:

	Code/Codice	Ø in mm	Ø out mm	Description/Descrizione	Coil length	Price
POLYURETHANE HOSE WITH STAINLESS STEEL SPIRAL / TUBO POLIURETANO CON SPIRALE IN ACCIAIO INOX						
Reinforced low-ware flexible hose for suction of liquids and abrasive materials / <i>Tube flessibile rinforzato antiabrasivo per aspirazione di liquidi e materiali abrasivi</i>						
	TA.0722.0000		40	Hose and hose cuffs included <i>Completo di tubo e manicotti</i>	3	€ 143,00
	TA.0048.0000	50	40		3	€ 139,00
	TA.0723.0000	50	40		5	€ 207,00
	TA.0724.0000	50	40		10	€ 378,00
	TA.0049.0000	50		Hose and hose cuffs included <i>Completo di tubo e manicotti</i>	3	€ 155,00
	TA.0733.0000	50			5	€ 227,00
	TA.0734.0000	50			10	€ 408,00
	TA.0077.0000	70		Hose and hose cuffs included <i>Completo di tubo e manicotti</i>	3	€ 232,00
	TA.0742.0000	70			5	€ 339,00
	TA.0743.0000	70			10	€ 607,00
	*TA.0757.0000	40		Not fractionable, without hose cuffs <i>Non frazionabile, manicotti non inclusi</i>	20	€ 684,00
	*TA.0761.0000	50			20	€ 725,00
	*TA.0763.0000	70			20	€ 1.070,00

*ADDITIONAL DISCOUNT FOR MINIMUM CUMULATIVE ORDER OF COILS LISTED ABOVE: 1 coil / rotolo +10%

*SCONTO QUANTITA' PER L'ACQUISTO MINIMO CUMULATIVO DI ROTOLI COMPLETI: 3 coils / rotoli +15%

5 coils / rotoli +20%

	Code/Codice	Ø in mm	Ø out mm	Description/Descrizione	Coil length	Price €/mt
May be ordered in 2,5/5/10mt or complete coil only <i>Ordinabile in tagli da 2,5/5/10mt o rotolo intero</i>	**TA.0078.0000		100	Without hose cuffs <i>Senza manicotti</i>	20	€ 79,00/mt
May be ordered in 2,5/5/10mt or complete coil only <i>Ordinabile in tagli da 2,5/5/10mt o rotolo intero</i>	**TA.0218.0000		120	Without hose cuffs <i>Senza manicotti</i>	20	€ 99,00/mt

**ADDITIONAL DISCOUNT FOR MINIMUM CUMULATIVE ORDER OF COILS LISTED ABOVE: 1 coil / rotolo +10%

**SCONTO QUANTITA' PER L'ACQUISTO MINIMO CUMULATIVO DI ROTOLI COMPLETI:

	Code/Codice	Ømm	Description/Descrizione	Price
OIL PROOF HOSE / TUBO GOMMA ANTIOLIO				
Rubber chloroprene insulating hose for suction of oil and chips mixtures / <i>Tubo in gomma cloroprene per aspirazione di trucioli misti ad olio.</i>				
	TA.0578.0000	40	Oil Proof Hose <i>Tubo gomma antiolio</i>	€ 47,00/mt
	TA.0593.0000	50		€ 51,00/mt
	TA.0642.0000	70		€ 70,00/mt

200 ° HEAT RESISTANT HOSE- TUBO GOMMA RESISTENTE FINO A 200 °

	TA.0260.0000	40	3m 200°Heat resistant hose with connections/ <i>3m Tubo gomma Calor resistente a 200° con manicotti</i>	€ 151,00
	TA.0640.0000	50	5m 200°Heat resistant hose with connections/ <i>5m Tubo gomma Calor resistente a 200° con manicotti</i>	€ 322,00

HOSE CUFFS / MANICOTTI
EVAFLEX

Code/Codice	Ømm	Ø In	Ø Out	Notes	Price/Prezzo
SL.0117.0000	40	50	40	Inlet hose cuff <i>Manicotto bocchettone</i>	€ 15,60
SL.0008.0000	40	40		Outlet hose cuff <i>Manicotto dritto</i>	€ 4,00
SL.0014.0000	50	50			€ 22,00

EVAFLEX ANTISTATIC - EVAFLEX CONDUTTIVO

SL.0117.0000	40	50	40	Inlet hose cuff <i>Manicotto bocchettone</i>	€ 15,60
SL.0013.0000	40	40		Outlet hose cuff <i>Manicotto dritto</i>	€ 14,40
SL.0017.0000	50	50			€ 22,90

SUPERFLEX POLYURETHANE ANTISTATIC - SUPERFLEX POLIURETANO ANTISTATICO

SL.0119.0000	40	50	40	Inlet hose cuff <i>Manicotto bocchettone</i>	€ 15,60
SL.0011.0000	40	40		Outlet hose cuff <i>Manicotto dritto</i>	€ 20,00
SL.0016.0000	50	50			€ 22,90
SL.0003.0000	70	70			€ 35,70
SL.0191.0000	100	100			€ 74,20

POLYURETHANE HOSE WITH STAINLESS STEEL SPIRAL - TUBO POLIURETANO CON SPIRALE IN ACCIAIO INOX

SL.6272.0000	40	50	40	Inlet hose cuff <i>Manicotto bocchettone</i>	€ 15,60
SL.6273.0000	40	40		Outlet hose cuff <i>Manicotto dritto</i>	€ 20,00
SL.0015.0000	50	50			€ 22,90
SL.0003.0000	70	70			€ 35,70
SL.0191.0000	100	100			€ 74,20

HOSE CLAMP - FASCETTA STRINGITUBO





SL.0925.0000	60	60			€ 9,00
SL.1084.0000	70	70			€ 10,00
SL.1557.0000	80	80			€ 10,00
SL.1211.0000	100	100			€ 11,00
SL.2200.0000	120	120			€ 13,00
SL.1892.0000	130	130			€ 14,00

ACCESSORY / ACCESSORI
Code/Codice
Ømm
Description/Descrizione
Price/Prezzo

	SL.0162.0000	40	PVC Brush <i>Pennello PVC</i>	€ 5,70
	SL.0137.0000	50		€ 8,50
	TA.0989.0000	40	Antistatic PVC Brush <i>Pennello PVC antistatico</i>	€ 12,30
	TA.1283.0000	50		€ 12,70
	SL.0161.0000	40	PVC Extension 0,5m <i>Prolunga PVC 0,5m</i>	€ 5,60
	SL.3075.0000	50		€ 12,20
	SL.0163.0000	40	PVC Lance <i>Lancia PVC</i>	€ 4,20
	TA.0052.0000	50	Nylon square brush 160x90mm <i>Spazzola nylon quadra 160x90mm</i>	€ 71,00
	TA.0055.0000	70		€ 91,00
	TA.0054.0000		Spare brush <i>Setole ricambio</i>	€ 32,00
	TA.0495.0000	40	Antistatic nylon square brush 160x90mm <i>Spazzola nylon quadra antistatica 160x90mm</i>	€ 76,00
	TA.0493.0000	50		€ 79,00
	TA.0484.0000	40	Spare antistatic brush <i>Setole ricambio per spazzola antistatica</i>	€ 49,00
	TA.0239.0000	40	Nylon Curved brush <i>Spazzola nylon tonda</i>	€ 58,00
	TA.0209.0000	50		€ 61,00
	TA.0210.0000		Spare brush <i>Setole ricambio</i>	€ 26,00
	TA.0494.0000	40	Antistatic Nylon Squared brush 100mm <i>Spazzola nylon ant. tonda 100mm</i>	€ 73,00
	TA.0492.0000	50		€ 70,00
	TA.0485.0000		Spare strips for Nylon ant. brush <i>Ricambio spazzola nylon ant.</i>	€ 39,00
	SL.1424.0000	40	Rubber lance <i>Lancia gomma</i>	€ 17,00
	TA.0163.0000	40	Rubber cone section nozzle with connector <i>Tronco conico in gomma con raccordo</i>	€ 48,00
	TA.0014.0000	50		€ 49,00
	TA.0147.0000	70		€ 62,00
	TA.0164.0000	40	Silicone cone section nozzle with stainless steel connector <i>Tronco conico in silicone con raccordo inox</i>	€ 73,00
	TA.0015.0000	50		€ 74,00
	TA.0130.0000	50	Rubber scraping nozzle with aluminium connector	€ 51,00
	TA.0131.0000	70	<i>Ventosa raschiante in gomma con raccordo in alluminio</i>	€ 58,00

	TA.0315.0000	50	Silicone scraping nozzle with stainless steel connector <i>Ventosa raschiante in silicone con raccordo inox</i>	€ 80,00
	TA.0122.0000	50	Conical rubber nozzle Ø50/20mm with connector <i>Terminale conico in gomma con raccordo</i>	€ 52,00
	TA.0365.0000	50	Conical silicone nozzle Ø50/20mm with stainless steel connector <i>Terminale conico in silicone con raccordo in acciaio inox</i>	€ 43,00
	TA.0023.0000	50	Aluminium flat nozzle 500mm <i>Lancia piatta in alluminio 500mm</i>	€ 42,00
	TA.0018.0000	70		€ 71,00
	SL.0172.0000	40	Aluminium lance 500mm <i>Lancia alluminio 500mm</i>	€ 38,00
	TA.0020.0000	50		€ 42,00
	TA.1037.0010	40	Stainless steel lance 500mm <i>Lancia acciaio inox 500mm</i>	€ 78,00
	TA.1038.0010	50		€ 90,00
	TA.0154.0000	50	Aluminium lance 1000mm <i>Lancia alluminio 1000mm</i>	€ 71,00
	TA.0019.0000	70		€ 102,00
	TA.0025.0000	50	Aluminium round nozzle 500mm <i>Bocchetta obliqua alluminio 500mm</i>	€ 35,00
	TA.0938.0000	70	Aluminium round nozzle with handle 500mm	€ 70,00
	TA.0123.0000	100	Bocchetta obliqua alluminio con maniglia 500mm	€ 85,00
	TA.0013.7016	50	Aluminium bend/ <i>Prolunga curva</i>	€ 81,00
	SL.0041.7016	70	Aluminium handgrip	€ 135,00
	SL.0062.7016	100	<i>Prolunga curva con maniglia</i>	€ 182,00
	TA.0124.0000	50	Steel probe pipe for bulk suction <i>Tubo sonda in acciaio per aspirazione grandi volumi</i>	€ 152,00
	TA.0964.7016	70	Steel probe pipe with air fluidification <i>Tubo sonda in acciaio con fluidificazione dell'aria</i>	€ 302,00
	TA.0871.7016	100		€ 377,00
	SL.0173.7016	40	Scraping steel nozzle 1200mm <i>Ventosa raschiante acciaio 1200mm</i>	€ 80,00
	SL.0140.7016	50		€ 80,00
	TA.0884.7016	70	With Wheels / <i>con ruote</i>	€ 185,00
	TA.0859.7016	100	With Wheels / <i>con ruote</i>	€ 208,00

CONNECTIONS / RACCORDI

	SL.0174.0000	40	Aluminium straight connection <i>Raccordo dritto in alluminio</i>	€ 15,00
	SL.0024.0000	50		€ 15,00
	SL.0096.0000	70		€ 19,00
	SL.0113.0000	100		€ 22,00
	SL.0174.0011	40	Straight stainless steel connection <i>Raccordo dritto in acciaio inox</i>	€ 27,00
	SL.0024.0011	50		€ 32,00
	SL.0026.0020	50	Steel bend connection <i>Raccordo curvo acciaio</i>	€ 44,00

DOUBLE BEND + ACCESSORIES / DOPPIA CURVA + ACCESSORI

	SL.0212.7016	40	Aluminium wand for floor brush / squeegee	€ 54,00
	SL.0170.7016	50	<i>Doppia curva alluminio per spazzola e ventosa pavimenti</i>	€ 81,00
	SL.0171.7016	70		€ 180,00
	TA.0225.0000	40	Stainless steel floor wand	€ 89,00
	SL.0170.0011	50	<i>Doppia curva acciaio inox</i>	€ 141,00
	TA.0438.0000	40	Floor brush for powders with wheels length 430mm	€ 72,00
	TA.0141.0000	50	<i>Spazzola per polveri con ruote 430mm</i>	€ 105,00
	TA.0143.0000	70		€ 130,00
	TA.0144.0000	50	Floor brush for powders with wheels length 550mm	€ 121,00
	TA.0146.0000	70	<i>Spazzola per polveri con ruote 550mm</i>	€ 145,00
	TA.0440.0000	40	Floor squeegee with wheels length 430mm	€ 72,00
	TA.0132.0000	50	<i>Ventosa pavimento con ruote 430mm</i>	€ 105,00
	TA.0134.0000	70		€ 130,00
	TA.0135.0000	50	Floor squeegee with wheels length 550mm	€ 121,00
	TA.0136.0000	70	<i>Ventosa pavimento con ruote 550mm</i>	€ 145,00
	TA.0227.0000	40	Stainless steel floor brush with wheels length 430mm	€ 125,00
	TA.0142.0000	50	<i>Spazzola pavimento acciaio inox con ruote 430mm</i>	€ 156,00
	TA.0323.0000	40	Stainless steel floor squeegee with wheels length 430mm	€ 125,00
	TA.0133.0000	50	<i>Ventosa pavimento acciaio inox con ruote 430mm</i>	€ 156,00

ADDITIONAL DISCOUNT FOR MINIMUM CUMULATIVE ORDER OF 10 DOUBLE BENDS AND 10 BRUSHES/SQUEEGEES LISTED ABOVE
 SCONTO QUANTITA' PER L'ACQUISTO MINIMO CUMULATIVO DI 10 DOPPIE CURVE E 10 SPAZZOLE/VENTOSE
 TRA QUELLE ELENCAE SOPRA:

+10%

DOUBLE BEND + ACCESSORIES / DOPPIA CURVA + ACCESSORI

	TA.0139.0000		Spare brush strip 430mm <i>Strip setole ricambio 430mm</i>	€ 16,00
	TA.0140.0000		Spare brush strip 550mm <i>Strip setole ricambio 550mm</i>	€ 18,00
	TA.0137.0000		Spare sylicon squeegee 430mm <i>Lamina silicone ricambio 430mm</i>	€ 14,00
	TA.0138.0000		Spare sylicon squeegee 550mm <i>Lamina silicone ricambio 550mm</i>	€ 15,00
	TA.0157.0000	40	Chromed floor wand <i>Doppia curva cromata</i>	€ 30,00
	TA.0159.0000	40	PVC Floor brush - dry <i>Spazzola pavimenti - polvere</i>	€ 22,00
	TA.0158.0000	40	PVC Floor squeegee - wet&dry <i>Ventosa pavimenti - liquidi</i>	€ 34,00
	TA.0990.0000	40	Antistatic PVC Floor brush - dry <i>Spazzola pavimenti antistatica - polvere</i>	€ 57,00



			Polyester filter class L <i>Filtro Poliestere con anello Cat.L</i>	
TA.1244.0000	1.000cm ²	PROVAC 150		€ 29,60
TA.1245.0000	2.000cm ²	PROVAC 300		€ 34,34
TA.1246.0000	7.000cm ²	PROVAC 702/703 C		€ 64,72



			Polyester bag filter class L <i>Filtro Poliestere a sacco Cat.L</i>	
FI.0292.0000	1.000cm ²	D800		€ 24,00
FI.0320.0000	2.000cm ²	WD1000		€ 35,00
FI.0319.0000	2.000cm ²	WD1500 - WD1500C		€ 46,00
FI.0303.0000	5.000cm ²	WD3000 << Year 2021		€ 64,00
FI.0308.0000	7.000cm ²	WD4500 << Year 2021		€ 88,00
FI.0293.0000	7.000cm ²	B4000 - B4500 - B40 <<Year 2016		€ 108,00
FI.0294.0000	10.000cm ²	B6000 - B60 <<Year 2016		€ 122,00



			Polyester star filter class L / <i>Filtro poliestere Cat.L</i>	
FI.0560.0000	8.000cm ²	W1		€ 120,00
FI.0304.0000	14.000cm ²	CHIPVAC200		€ 189,00
FI.0120.0000	20.000cm ²	W2 - W3 - W2 Infini - W3 Infini - M50 SILOVAC100		€ 216,00
FI.0318.0000	30.000cm ²	CHIPVAC400		€ 284,00
FI.0407.0000	35.000cm ²	M70 - M90		€ 305,00
FI.0078.0000	50.000cm ²	SILOFILTER200 - SILOFILTER600 - SILOFILTER1000		€ 437,00
FI.0527.0000	70.000cm ²	MHD100 - MHD130 - MHD150 - MHD180 - MHD180HV - MHD200		€ 483,00

Nomex.



			Polyester Nomex star filter <i>Filtro a stella Poliestere Nomex</i>	
FI.0565.0000	8.000cm ²	W1		€ 249,00
FI.0353.0000	14.000cm ²	CHIPVAC 200		€ 298,00
FI.0130.0000	20.000cm ²	W2 - W3 - W2 Infini - W3 Infini - M50		€ 324,00
FI.0442.0000	35.000cm ²	M70 - M90		€ 474,00
FI.0165.0000	70.000cm ²	MHD100 - MHD130 - MHD150 - MHD180 - MHD180HV - MHD200		€ 602,00

 Polyester **Antistatic** star filter class M
*Filtro a stella poliestere **Antistatico** Cat. M*

FI.0566.0000	8.000cm ²	W1	€ 175,00
FI.0528.0000	8.000cm ²	SK10-20-30-40	€ 160,00
FI.0154.0000	20.000cm ²	W2 - W3 - W2 Infini - W3 Infini - M50 SILOVAC100	€ 328,00
FI.0441.0000	35.000cm ²	M70 - M90	€ 502,00
FI.0103.0000	50.000cm ²	SILOFILTER 200 - SILOFILTER 600 SILOFILTER 1000	€ 541,00
FI.0140.0000	70.000cm ²	MHD100 - MHD130 - MHD150 - MHD180 - MHD180HV - MHD200	€ 596,00

 Polyester **PTFE antistatic** star filter class M
*Filtro a stella **Poliestere PTFE** antistatico Cat. M*

FI.0567.0000	8.000cm ²	W1	€ 314,00
FI.0230.0000	20.000cm ²	W2 - W3 - W2 Infini - W3 Infini - M50 SILOVAC100	€ 424,00
FI.0521.0000	35.000cm ²	M70 - M90	€ 685,00
FI.0285.0000	50.000cm ²	SILOFILTER 200 - SILOFILTER 600 SILOFILTER 1000	€ 932,00
FI.0141.0000	70.000cm ²	MHD100 - MHD130 - MHD150 - MHD180 - MHD180HV - MHD200 - SILOVAC 600	€ 985,00

 Polyester Teflon class M filter **Hydro-Oleophobic**
*Filtro Poliestere Teflon Cat. M **Idro-Oleofobico***

FI.0568.0000	8.000cm ²	W1	€ 230,00
FI.0375.0000	14.000cm ²	CHIPVAC200	€ 359,00
FI.0376.0000	14.000cm ²	OILVAC130 - OILVAC200 OILVAC300 - OIL- VAC450 - OILVAC 600	€ 359,00
FI.0382.0000	20.000cm ²	W2 - W3 - W2 Infini - W3 Infini - M50 SILOVAC100	€ 400,00
FI.0383.0000	30.000cm ²	CHIPVAC400	€ 540,00
FI.0444.0000	35.000cm ²	M70 - M90	€ 605,00

 Polyester bag filter Class L
Filtro a sacco poliestere Cat. L

FI.0300.0000	12.250cm ²	TS30 < year 2016	€ 120,00
FI.0315.0000	17.500cm ²	TS70 < year 2016	€ 153,00

FILTERS / FILTRI
Models/Modello
Code
mm Description / Descrizione
Price/Prezzo

 WD 3000
 WD 4500
 >>Year 2022

DRY KIT
 FI.0133.0000

 Ø420 Polyester bag filter Class L
Filtro a sacco poliestere Cat. L

€ 117,00

FI.0131.0000

 Ø420 Nylon filter with rubber band
Filtro Nylon con elastico

€ 161,00

WET KIT
 FI.0136.0000

 Ø420 Polypropilene filter
Filtro in Polipropilene

€ 154,00

SL.0675.0000

 Ø420 Fibre filter
Filtro in Filtro

€ 24,00

MOTOR PROTECTION FILTERS / FILTRI PROTEZIONE MOTORE

OILVAC 60

FI.0363.0000

 Ø235 PPL Filter 100µ
 H270 *Filtro PPL 100µ*

€ 115,00

OILVAC 100

FI.0445.0000

 Ø260 PPL Filter 100µ
 H70 *Filtro PPL 100µ*

€ 65,00

OILVAC 100

FI.0446.0000

 Ø260 Fibre Filter nr. 2 pieces
 2xH30 *Filtro Fibra nr. 2 pezzi*

€ 27,00

SOLIDS AND CHIPS SEPARATION / FILTRI SEPARAZIONE LIQUIDO/SOLIDO

 OILVAC 100
 OILVAC 130

FI.0449.0000

 Ø415 PPL **fine dust separation** filter 300µ
 H255 *Filtro separazione polveri sottili*
PPL 300µ

€ 130,00

OILVAC 200

FI.0403.0000

 505x315
 H330

€ 174,00

OILVAC 300

FI.0279.0000

 Ø410
 H450

€ 140,00

 OILVAC 450
 OILVAC 600

FI.0520.0000

 Ø260
 H280

€ 93,00

 OILVAC 100
 OILVAC 130

FI.0450.0000

 Ø415 PPL **fine dust separation** filter 100µ
 H255 *Filtro separazione polveri sottili*
PPL 100µ

€ 195,00

OILVAC 200

FI.0404.0000

 505x315
 H330

€ 263,00

OILVAC 300

FI.0278.0000

 Ø410
 H450

€ 168,00

 OILVAC 450
 OILVAC 600

FI.0451.0000

 Ø260
 H280

€ 120,00

CARTRIDGE AND HEPA FILTERS / FILTRI HEPA E A CARTUCCIA

 DEDUST 30
 SILOS

 FI.0306.0000
 Series<2016

 Ø228 Polyester **antistatic** cartridge filter Class M
 H400 *Filtro cartuccia poliestere antistatico Cat.M*

€ 235,00

DEDUST 50

FI.0330.0000

 Ø320 Polyester antistatic cartridge filter Class M
 H600 *Filtro cartuccia poliestere antistatico Cat.M*

€ 313,00

 M PN Series
 MHD PN Series
 SILOFILTER

FI.0179.0000

 Ø150 Polyester **antistatic** cartridge filter Class M
 H700 *Filtro cartuccia poliestere antistatico Cat.M*

€ 234,00

PTFE

 M PN Series
 MHD PN Series
 SILOFILTER

FI.0210.0000

 Ø150 Polyester **antistatic** cartridge filter
 Class M PTFE
Filtro cartuccia poliestere antistatico
Cat.M PTFE

€ 333,00

FILTERS / FILTRI
Models/Modello
Code
Ømm
Description / Descrizione
Price/Prezzo

DEDUST 1-2

FI.0483.0000

Ø325

 Polyester **antistatic** cartridge filter Class M
 H600 *Filtro cartuccia poliestere **antistatico** Cat.M*

€ 350,00

DEDUST 4-8

FI.0482.0000

 Ø325
 H700

€ 350,00

PTFE

DEDUST 1-2

FI.0487.0000

 Ø325
 H600

 Polyester **antistatic** cartridge filter
 Class M PTFE
*Filtro cartuccia poliestere **antistatico**
 Cat.M PTFE*

€ 437,00

DEDUST 4-8

FI.0502.0000

 Ø325
 H700

€ 437,00



SL.0587.0000

Ø60

 Air exhaust diffuser antistatic polyester
 filter
*Filtro diffusore poliestere antistatico scari-
 co aria*

€ 25,00

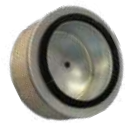

W 1

FI.0571.0000

Ø220

 Class Hepa 14 Cartridge filter
 H80 *Cartuccia filtrante classe Hepa H14*

€ 140,00

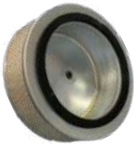

W 2

FI.0013.0000

 Ø330
 H98

€ 248,00

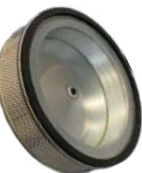
 W 3
 W3 Infini
 M 50

FI.0003.0000

 Ø430
 H92

€ 380,00

 M 70 - M 90
 MHD 100
 MHD 130HV
 MHD 180HV
 CHIPVAC 400

FI.0005.0000

 Ø430
 H163

€ 466,00

 MHD 130
 MHD 150
 MHD 200

FI.0006.0000

 Ø430
 H302

€ 661,00

SPARE PARTS / RICAMBI	Models/Modello	Code	Lt.	Description / Descrizione	Price/Prezzo
	WD 1500	KT.1202.0000	65	Stainless steel container with catches <i>Contenitore inox con ganci</i>	€ 163,00
	WD 1500C	KT.1203.0000	65		€ 185,00
	WD 3000	KT.1204.0000	60	Steel container with catches + inlet <i>Contenitore in acciaio con bocchettone e</i>	€ 299,00
	WD 4500	KT.1205.0000	100	<i>ganci</i>	€ 459,00
	W 2	KT.1395.0000	40	Container with leverage <i>Contenitore con leveraggio</i>	€ 325,00
	W 3	KT.1208.0000	65		€ 406,00
	W 3 Infini				
	W 3 100Lt. M Series	KT.1210.0000	100		€ 525,00
	MHD Series	KT.0171.5017	160		€ 854,00
	W 2	GI.0083.0000	420	Filter chamber upper gasket <i>Guarnizione reggifiltro</i>	€ 23,00
	W 3 W 3 Infini M Series				
	MHD Series Silofilter	GI.0051.0000	560		€ 34,00
	W 3	GI.0108.0000	420	Oilproof neoprene gasket <i>Guarnizione antiolio in nbr</i>	€ 47,00
	M Series Oilvac Series				
	W1 OILVAC 450/600	GI.0329.0000	280		€ 17,00
	W 1	SL.3015.0000		Filter fastener <i>Fascetta fermafiltro</i>	€ 18,00
	W 2	SL.0674.0000			€ 26,00
	W 3 W 3 Infini M Series				
	MHD Series SILOVAC 600	SL.0477.0000			€ 38,00

Base plate and top cover gaskets / Guarnizioni basamento e coperchi



GI.0141.0000	3x30 Adhesive mousse gasket <i>Guarn. gomma spugna grigia adesiva 3x30</i>	€ 12,00/m
GI.0146.0000	Monophase base plate gasket <i>Guarnizione basamento</i>	€ 14,00/m

Filter chamber - container gaskets / Guarnizioni camera - Contenitore

Gasket length on request / *Lunghezza delle guarnizioni a richiesta*

- Ø280 - L 920 mm
- Ø420 - L 1400 mm
- Ø460 - L 1600 mm
- Ø560 - L 1800 mm

W1 - W2 - W3 - W3 Infini - M Series - MHD Series	GI.0140.0000	10x22 Adhesive mousse gasket <i>Guarn. grigia mousse adesiva 10x22</i>	€ 18,00/m
CHIPVAC 200	TA.1226.0000	Black Mousse gasket kit <i>Kit Guarnizione nera mousse</i>	€ 18,00
OILVAC 200	TA.1228.0000		€ 18,00
CHIPVAC 400	TA.1227.0000		€ 23,50
	MC.0883.0000	3M Glue tube Oil-resistant <i>Tube colla antiolio 3M</i>	€ 85,50
W 2	GI.0169.0000	Inlet gasket / <i>Guarn. bocchettone</i>	€ 8,40
WD 4500 - W 3 - M Series	GI.0040.0000	Inlet gasket / <i>Guarn. bocchettone</i>	€ 12,00

	Code	Description / Descrizione	Price/Prezzo
	GA.0580.0000 Suitable for >2017 Models	DU-PUY By-Pass Motor 1100w, 240V, 50-60Hz <i>Motore DU-PUY By-Pass 1100w, 240V, 50-60Hz</i>	€ 132,00
	GA.0581.0000	DU-PUY By-Pass Motor 1100w, 120V, 60Hz <i>Motore DU-PUY By-Pass 1100w, 120V, 60Hz</i>	€ 152,00
	GA.0355.0000 Suitable for <2017 Models	DU-PUY By-Pass Motor 1000w, 240V, 50-60Hz <i>Motore DU-PUY By-Pass 1000w, 240V, 50-60Hz</i>	€ 176,00
	GA.0488.0000 Suitable for <2023 Models	DU-PUY By-Pass Motor 1300w, 3 Stage, 240V, 50-60Hz <i>Motore DU-PUY By-Pass 1300w, 3 Stadi, 240V, 50-60Hz</i>	€ 255,00
	GA.0695.0000 Suitable by >2023 Models	DU-PUY By-Pass Motor 1600w, 3 Stage, 240V, 50-60Hz <i>Motore DU-PUY By-Pass 1600w, 3 Stadi, 240V, 50-60Hz</i>	€ 345,00
	GA.0365.0000	Brushless motor <i>Motore brushless</i>	€ 799,00
	EP.1476.0000	Carbon brush for GA.0580.0000 DU-PUY > 2017 <i>Carboncino per GA.0580.0000 DU-PUY > 2017</i>	€ 13,00
	EP.1536.0000	Carbon brush for GA.0581.0000 DU-PUY <i>Carboncino per GA.0581.0000 DU-PUY</i>	€ 13,00
	GA.0367.0000	Carbon brush for GA.0355.0000 DU-PUY < 2017 <i>Carboncino per GA.0335.0000 DU-PUY < 2017</i>	€ 15,00

SCONTO QUANTITA' PER L'ACQUISTO MINIMO CUMULATIVO DI :
10 MOTORS - 10 MOTORI
+10%



CVS COMPONENTS

COMPONENTI PER IMPIANTI CENTRALIZZATI



Hopper level sensor / Sensori di livello per tramoggia

EP.0872.0000 Rotary Level sensor 24AC* IP66 1"1/2 GAS
Sonda di livello rotante 24AC* IP66 1"1/2 GAS

Powders
or granules
Polveri o
granuli

€ 688,00

EX.0001.0000 Rotary Level sensor 24AC* IP66 1"1/2 GAS
II 1/2D Ex t IIIC T120°C
Sonda di livello rotante 24AC* IP66 1"1/2 GAS
II 1/2D Ex t IIIC T120°C



€ 836,00



EP.0846.0000 Helic level sensor 24VDC IP65 2"1/2 GAS with rod
L=500
Sonda di livello ad elica 24VDC IP65 2"1/2 GAS con
asta L=500

Powders
or granules
Polveri o
granuli

€ 765,00

Level sensor for hopper and big bag / Sensori di livello per tramoggia e big bag

EP.0145.0000 Capacitive level sensor for hopper, big bag, container
20 ÷ 250 VAC M30x1,5 IP67
Sonda di livello capacitiva per tramoggia, big bag, conte-
nitore 20 ÷ 250 VAC M30x1,5 IP67

Homog. granu-
late material
Granulari
mat. omogeneo

€ 188,00

EX.0101.0000 Capacitive level sensor 10÷55VDC NO+NC M30x1.5
IP 67 II 3D Ex tc IIIC T85°C Dc X-25< Ta<60°C
Sonda di livello capacitiva 10÷55VDC NO+NC M30x1.5
IP 67 II 3D Ex tc IIIC T85°C Dc X-25< Ta<60°C



€ 226,00



EP.0790.0000 Vibrating level indicator 20-40VDC IP67 THREA-
DING 1"1/2 GAS AISI316
L'indicatore di livello a vibrazione 20-40VDC IP67
FILETTATURA 1"1/2 GAS AISI316

Powders
or granules
Polveri o
granuli

€ 931,00

EX.0306.0000 Vibrating level indicator 20-72VDC IP66 THREA-
DING 1"1/2 GAS AISI316 II 1/3D Ex ta/tc IIIC T Da/Dc
L'indicatore di livello a vibrazione 20-72VDC IP66
FILETTATURA 1"1/2 GAS AISI316 II 1/3D Ex ta/tc IIIC
T Da/Dc



€ 1.396,00

Big bag level sensors / Sensori di livello per big bag

2 Level sensors with microwave barriers + TRANSMITTER VDC/VAC
Microwave barriers are used to detect all types of suspended solids based on
microwaves (transmitter/receiver concept).

No contact
with material
No contatto
con materiale

Upon request
Su richiesta

2 Sensori di livello con barriere a microonde + TRASMETTITORE VDC/VAC
Le barriere a microonde vengono utilizzate per rilevare tutti i tipi di solidi sospesi
in base alle microonde (principio trasmettitore/ricevitore).

Filter sensors / Sensori per filtro





KT.1637.0000 Differential pressure switch 18-36 VDC; for filter clog-
ging control. Complete with pipe fittings. IP 67
Measuring range ±1000 mbar. Display led
Pressostato differenziale 18-36 VDC; per controllo inta-
samento filtro. Completo di raccorderia. IP 67
Campo di misurazione ±1000 mbar. Display led

€ 627,00





Manual non-continuous discharge / Scarico non continuo manuale

	SL.0200.7011	150	Balanced flap discharge. <i>Scarico a paletta bilanciata.</i>	Granular material <i>Materiale granulare</i>	€ 425,00
	SL.5263.7011	250			€ 608,00
	TA.0945.5017	150	Counterweighted and balanced flap discharge with protection cone. <i>Scarico a paletta bilanciata e cono di protezione</i>	Granular material <i>Materiale granulare</i>	€ 941,00
	TA.0907.5017	250			€ 1.126,00
	SL.1314.0000	150	Manual sliding damper. <i>Serranda ghigliottina manuale</i>	Granular material <i>Materiale granulare</i>	€ 490,00
	SL.1315.0000	250			€ 545,00
	EP.1071.0000	150	Heavy series manual sliding damper with technopolymer coated frame to increase abrasion resistance. <i>Serranda ghigliottina manuale serie pesante con telaio rivestito da tecnopolimero per aumento resistenza all'abrasione.</i>	Granular / fine material <i>Materiale granulare / fine</i>	€ 1.110,00
	SL.4340.0000	250			€ 1.306,00
	EP.1072.0000	150	Heavy series manual sliding damper II 3D T6 (85°C) <i>Serranda ghigliottina manuale serie pesante II 3D T6</i>		€ 1.180,00
	EP.1073.0000	250	(85°C)		€ 1.400,00
	EP.1064.0000	150	Manual butterfly valve V2FS Aluminum Body, SINT.MC coated disk, BLACK NBR seal <i>Valvola a farfalla manuale V2FS</i> <i>Corpo in Alluminio, Disco rivestito in SINT.MC, Sede in NBR NERO</i>	Dusty material <i>Polvere</i>	€ 403,00
	SL.3876.0000	250			€ 454,00
	EP.1065.0000	150	Manual butterfly valve V2FS Ex II 3D T4 Aluminum Body, Cast iron disk, BLACK NBR seal <i>Valvola a farfalla manuale V2FS Ex II 3D T4</i> <i>Corpo in alluminio, Disco in GHISA, Sede in NBR NERO</i>	Dusty material <i>Polvere</i>	€ 484,00
	EP.1066.0000	250			€ 554,00
	EP.1067.0000	150	Abrasion resistant manual butterfly valve V2FS Cast iron body, Chrome-plated disk, Resicoat seal. <i>Valvola a farfalla manuale antiabr. V2FS</i> <i>Corpo in ghisa, Disco in cromato, Sede in Resicoat</i>	Abrasive material <i>Materiale abrasivo</i>	€ 760,00
	SL.4339.0000	250			€ 1.440,00



Electropneumatic non-continuous discharge / Scarico non continuo elettropneumatico

	TA.0996.5017	150	Balanced flap discharge with electropneumatic cylinder and protection cone. <i>Scarico a paletta bilanciata con cilindro elettropneumatico e cono di protezione</i>	Granular material <i>Materiale granulare</i>	€ 1.090,00
	TA.0908.5017	250			€ 1.274,00
	EP.0266.0000	150	Electropneumatic 24AC sliding damper <i>Serranda ghigliott. elettropneumatica 24AC</i>	Granular material <i>Materiale granulare</i>	€ 978,00
	EP.0267.0000	250			€ 1.118,00
	EX.0041.0000	150	Electropneumatic sliding damper 24AC II 2GD <i>Serranda ghigliott. elettropn 24AC II 2GD</i>		€ 1.204,00
	EX.0042.0000	250			€ 1.295,00

Electropneumatic non-continuous discharge / Scarico non continuo elettropneumatico

	EP.1074.0000	150	ELPN heavy series sliding damper. Frame coated with a technopolymer to increase abrasion resistance 24DC <i>Serranda ghigliottina ELPN serie pesante. Telaio rivestito da un tecnopolimero per aumentare la resistenza all'abrasione 24DC</i>	Granular / fine material <i>Materiale granulare / fine</i>	€ 1.680,00
	EP.0969.0000	250			€ 2.322,00
	EP.1075.0000	150	Electropneumatic sliding damper heavy series 24DC II 3D T6 (85°C) <i>Serranda ghigliottina elettropneumatica serie pesante 24DC II 3D T6 (85°C)</i>	Granular material <i>Materiale granulare</i>	€ 2.824,00
	EP.1076.0000	250			€ 2.763,00
	EP.1068.0000	150	Electropneumatic butterfly valve V2FS Aluminum Body, SINT.MC coated disk, BLACK NBR seal <i>Valvola a farfalla elettropneumatica V2FS Corpo in Alluminio, Disco rivestito in SINT.MC, Sede in NBR NERO</i>	Dusty material <i>Polvere</i>	€ 732,00
	EP.0946.0000	250			€ 1.045,00
	EP.1069.0000	150	Electropneumatic butterfly valve V2FS - Ex II 3D T4 Aluminum body, Cast iron disk, BLACK NBR seal <i>Valvola a farfalla elpn. V2FS - Ex II 3D T4 Corpo in alluminio, Disco in GHISA, Sede in NBR NERO</i>	Dusty material <i>Polvere</i>	€ 937,00
	EP.1070.0000	250			€ 1.310,00
	EP.0968.0000	250	Abrasion resistant ELPN butterfly valve. V2FS Cast iron body, Chrome-plated disk, Resicoat Seal <i>Valvola a farfalla ELPN antiabr. V2FS Corpo in ghisa, Disco in cromato, Sede in Resicoat</i>	Abrasive dusty material <i>Polvere abrasiva</i>	€ 2.728,00

Electropneumatic continuous discharge / Scarico continuo elettropneumatico

	TA.0984.5017	250	Double ELPN heavy series sliding damper 30 lt Tank <i>Doppia Serranda ghigliottina elettropneumatica serie pesante. Polmone 30 lt</i>	Granular material <i>Materiale granulare</i>	€ 5.660,00
	TA.0910.5017	250	Double electropn. Anti abrasion butterfly. 30 lt Tank <i>Doppia farfalla elettropn. Antiabrasiva. Polmone 30 lt</i>	Abrasive dusty material <i>Polvere abrasiva</i>	€ 5.824,00
	TA.0995.5017	250	Double electropneumatic butterfly II 3D T4 (135°C) <i>Doppia farfalla elettropneumatica II 3D T4 (135°C)</i>	Dusty material <i>Polvere</i>	€ 6.698,00

Electropneumatic continuous discharge / Scarico continuo elettropneumatico

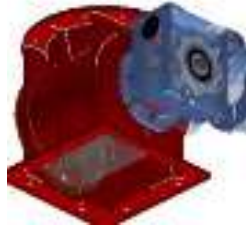

EP.0528.0000	150	Rotovalve for discharge 2 l/turn 0,55 kW (RVR02) Vel. MAX: 2Lt/turn Ø150 IN/OUT 250x250 + Seal in Vulkollan <i>Rotovalvola per scarico 2 l/giro 0,55 kW (RVR02) Vel. MAX: 2 Lt/giro Ø150 IN/OUT 250x250 + Bavette in Vulkollan</i>	Dusty and/or granular material <i>Materiale polveroso e/o granulare</i>	€ 2.870,00
EP.0485.0000	250	Rotovalve for discharge 10 l/turn 0,75 kW (RVR10) Vel. MAX: 10 Lt / turn IN Ø250/OUT 250x250 + Seal in Vulkollan <i>Rotovalvola per scarico 10 l/giro 0,75 kW (RVR10) Vel. MAX: 10 Lt / giro IN Ø250/OUT 250x250 + Bavette in Vulkollan</i>	Dusty and/or granular material <i>Materiale polveroso e/o granulare</i>	€ 5.220,00
EX.0240.0000	250	ATEX Rotovalve for discharge 10 l/giro 0,75 kW (RVR10) Vel. MAX: 10 Lt / Turn II 1D/3D c T135°C IN Ø250/OUT 250x250 + Seal in Vulkollan <i>ATEX Rotovalvola per scarico 10 l/giro 0,75 kW (RVR10) Vel. MAX: 10 Lt / giro II 1D/3D c T135°C IN Ø250/OUT 250x250 + Bavette in Vulkollan</i>	Dusty and/or granular material <i>Materiale polveroso e/o granulare</i>	€ 6.090,00
EP.0970.0000	250	ATEX Rotovalve for discharge 10 l/giro 0,75 kW ANTI ABRASION chrome-plated body (RVR10) Vel. MAX: 10 Lt / turn IN Ø250/OUT 250x250 + Seal in Vulkollan <i>ATEX Rotovalvola per scarico 10 l/giro 0,75 kW ANTIBRASIVA corpo cromato (RVR10) Vel. MAX: 10 Lt / giro IN Ø250/OUT 250x250 + Bavette in Vulkollan</i>	Abrasive dusty and/or granular material <i>Materiale polveroso e/o granulare abrasivo</i>	€ 8.270,00
		Kit 8 Seal in Vulkollan spare part ROT D150 <i>KIT 8 Bavette in Vulkollan ricambio ROT D150</i>		€ 970,20
		Kit 8 Seal in Vulkollan spare part ROT D250 <i>KIT 8 Bavette in Vulkollan ricambio ROT D250</i>		€ 1.038,45

Flanged discharge pipe / Tubo flangiato per scarico



TA.0987.5017	150	Flanged discharge pipe with filter <i>Tubo flangiato per scarico con filtro</i>	Butterfly Ghigliottina	€ 210,00
--------------	-----	--	------------------------	----------

TA.0986.5017	250			€ 280,00
--------------	-----	--	--	----------



TA.0988.5017	150	Flanged discharge pipe with filter <i>Tubo flangiato per scarico con filtro</i>	Rotovalve Rotovalvola	€ 460,00
--------------	-----	--	-----------------------	----------

TA.0985.5017	250			€ 598,00
--------------	-----	--	--	----------

Pneumatic vibrator / Vibratore pneumatico



Pneumatic rotary vibrator with turbine. They generate very high frequencies and centrifugal forces. They are particularly suitable to be integrated in existing plants such as silos cones or hoppers. **(Minimum purchase of two piece)**
Vibratore pneumatico rotazionale a turbina. Generano altissime frequenze e forze centrifughe. Sono particolarmente idonei per l'integrazione in impianti esistenti come i silos o tramogge. (Acquisto minimo due pezzi)

€ 540,00 cad.

Vibraflow



Air flow generating pneumatic vibrator. They are particularly suitable for integration into existing systems such as silo cones or hoppers.
Vibratore pneumatico generante flusso d'aria. Sono particolarmente idonei per l'integrazione in impianti esistenti come i silos o tramogge.

€ 236,00

Electric vibrator / Vibratore elettrico



Mechanical electric vibrator on the hopper cone (for sticky dust)
Vibratore elettro-meccanico sul cono tramoggia per scarico materiali impaccanti

€ 913,00

Standard push-button panels / Pulsantiere standard



EP.1257.0000 Push button panel in metal box IP65
Pulsantiera in box metallico IP65

Green start light
Red stop light
Emergency
Start luminoso verde
Stop luminoso rosso
Emergenza

€ 340,00



EX.0395.0000 Atex Z21 - Z22 push button panel in metal box IP65
Pulsantiera in box metallico IP65 Atex Z21 - Z22



€ 465,00

Components / Componenti

Upon Request
Su Richiesta Interconnection on Ø500 chamber for vent panels
Interconnessione su camera Ø500 per pannelli di sfogo

Interconnection on Ø560 chamber for vent panels
Interconnessione su camera Ø560 per pannelli di sfogo

Interconnection on Ø780 chamber for vent panels
Interconnessione su camera Ø780 per pannelli di sfogo

Interconnection on Silovac-Silofilter 1200 for vent panels
Interconnessione su Silovac-Silofilter 1200 per pannelli di sfogo

Upon Request

EX.0152.0000 D400* Explosion vent panel
*Membrana di sfogo a rottura D400**

External**
*Esterno***

Upon Request

* The size and price of the vent membrane will be based on the parameters Pmax ,Kst communicated to Du-Puy
** La dimensione e il prezzo della membrana di sfogo sarà in funzione ai parametri Pmax ,Kst comunicati a Du-Puy*

** Canalize the vent in a safe area
*** Canalizzare lo sfogo in zona sicura*



EX.0301.0000 Vent valve with flame breaker that cannot be closed and can be re-used 266EVN2.0NC* - IID St2
Valvole di sfogo con rompifiamma non richiudibile con possibilità di riutilizzo 266EVN2.0NC - IID St2*

Internal/External**
*Interno/Esterno***

Upon Request

* The size and price of the vent membrane will be based on the parameters Pmax ,Kst communicated to Du-Puy
** La dimensione e il prezzo della membrana di sfogo sarà in funzione ai parametri Pmax ,Kst comunicati a Du-Puy*

** Not suitable for metal dust
*** No per polveri metalliche*

*** Ensure safety distance according to the valve manual
**** Garantire distanza di sicurezza secondo manuale della valvola*



EX.0345.0000 D100* cut-off flap valve
*Valvola flap di non ritorno D100**

Internal/External
Interno/Esterno

Upon Request

EX.0350.0000 D150* cut-off flap valve
*Valvola flap di non ritorno D150**

Internal/External
Interno/Esterno

Upon Request

*Directive 2014/34/EU (ATEX)
**In accordo con la direttiva 2014/34/EU (ATEX)*

These devices must always be combined with non-return flap valves to ensure complete protection of the system.
Questi dispositivi devono sempre essere associati a valvole flap di non ritorno per garantire una protezione completa dell' impianto



DU-PUY Srl · Via Enrico de Nicola 27 · 10036 Settimo Torinese (TO)
Tel. +39 011 8975444 · Fax +39 011 2484517
info@dupuy.it · www.dupuyvacuums.com